

REVISION HISTORY				
REV	ECN	DESCRIPTION	DATE	APPROVED
A	XXXXXX	RELEASE	3/20/1951	RH
B	F130043	REDRAWN CAD, WAS GROUP DRAWING, BOM WAS BUILD-THRU, ADD F03401700	3/28/2013	dmjohnson

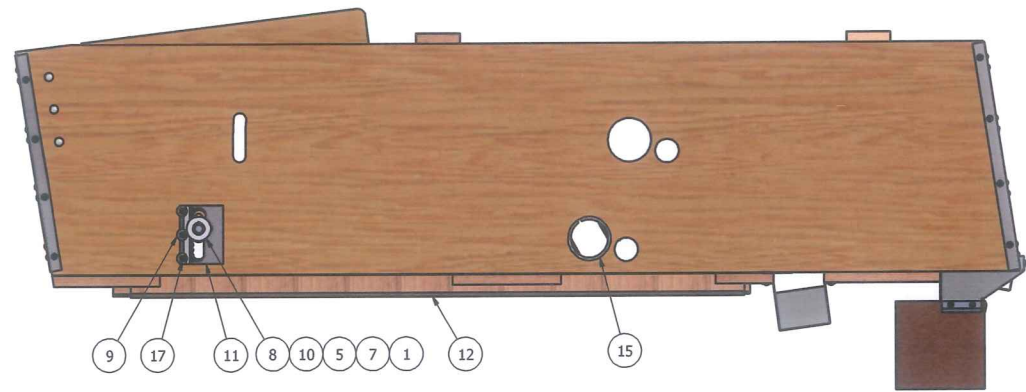

LEFT SIDE VIEW, BOTTOM ROCKER INSTALLATION

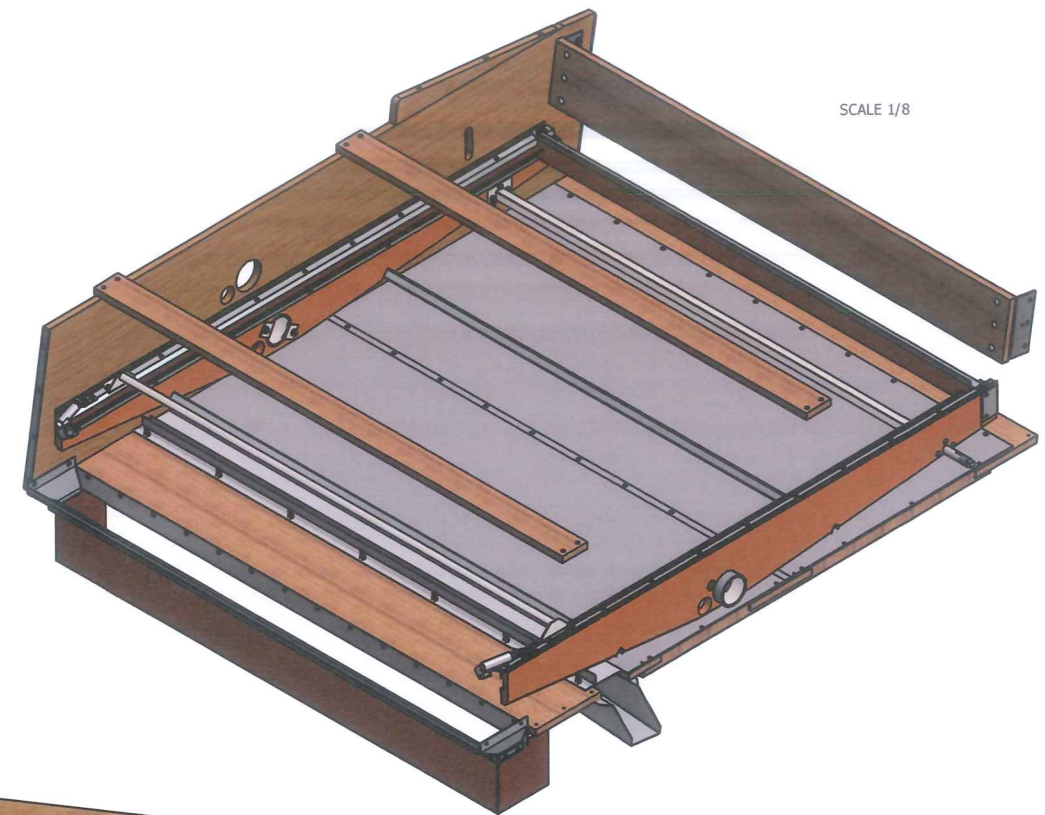

SCALE 1/8

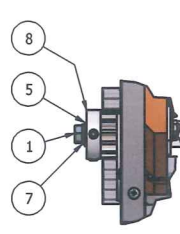

DETAIL A
SCALE 0.31 : 1

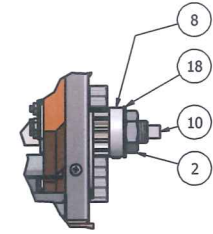

DETAIL B
SCALE 0.31 : 1

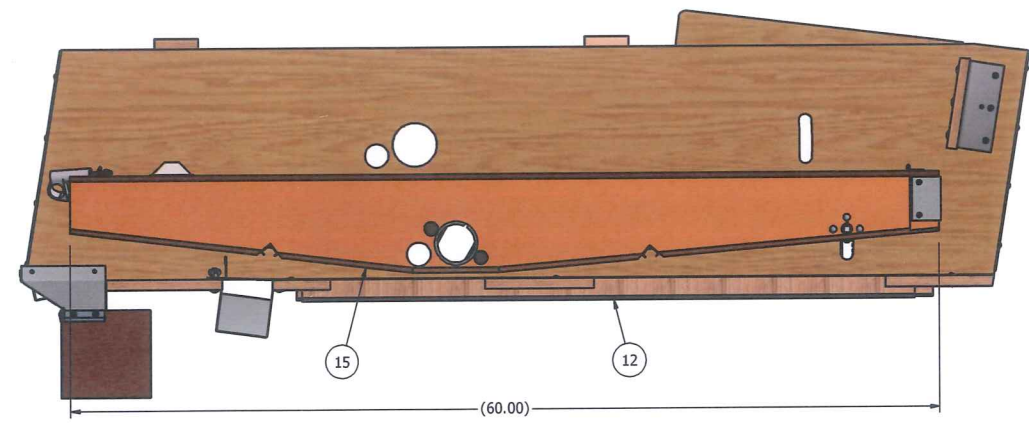

RIGHT SIDE CUTAWAY

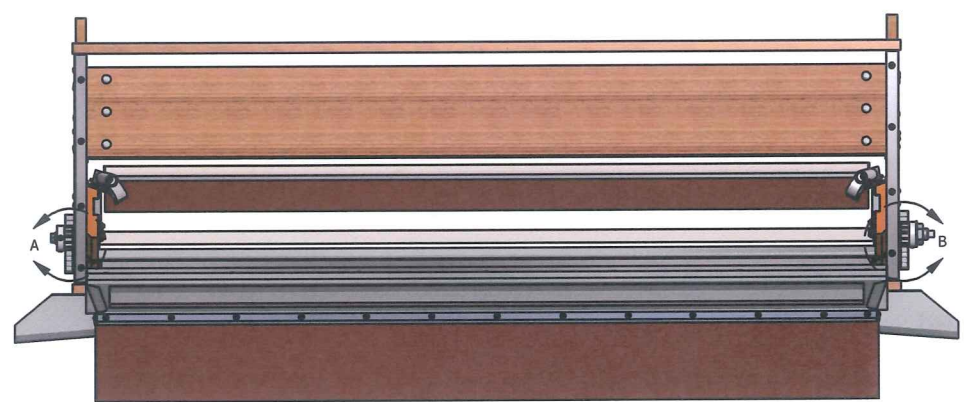

FRONT VIEW, RH ARRANGEMENT SHOWN
 F01608303 MAY BE FLIPPED FOR LH ARRANGEMENT
 ASSEMBLE PINION COMPONENTS OPPOSITE

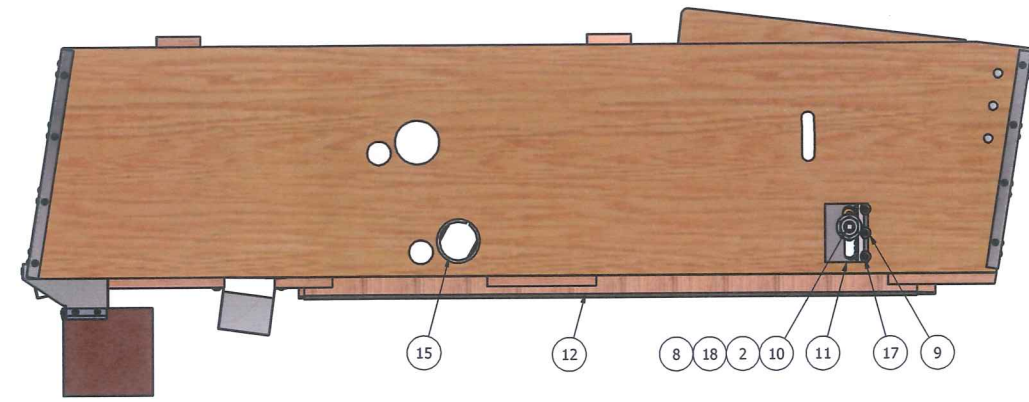

STEP 1: RIGHT SIDE VIEW, BOTTOM ROCKER INSTALLATION

ITEM	PART NUMBER	QTY	DESCRIPTION
19	SALES ORDER	2	FRAME ASSY, PERF SCREEN, 60" X #8
18	F84621034	2	WASHER, FLT .750 X 1.750 X .062
17	F83450101	12	SMS, PAN X HD, #8 X 1.00"
16	F82071401	2	STUD, DOWEL 1/4-20 X 2.50"
15	F03500110	1	ROCKER ASSY, BOTTOM, TOP SHOE, 298D
14	F03500010	1	ROCKER ASSY, TOP, TOP SHOE, 298D
13	F03401700	1	APRON ASSY, 1.25 X 57.5", SEED #8
12	F03000002	1	SHOE ASSY, TOP, 298D
11	F01801700	4	PLATE, ESCUTCHCHEON, TILT ROD ROCKER
10	F01608303	2	SHAFT, TILTING ROD, 3/4 X 60.50" #8
9	F01200300	4	RACK, STRAIGHT ROCKER ADJUSTING
8	F01200203	4	PINION, BRUSH ADJ. 13 TOOTH W/SET SCREWS
7	66444400	2	WASHER, LOCK HELICAL 3/8"
6	66443300	2	WASHER, LOCK HELICAL 1/4"
5	66404400	2	WASHER, FLAT 3/8" NARROW TYPE A
4	66403300	2	WASHER, FLAT 1/4"
3	66363300	2	NUT, WING 1/4-20 TYPE B STYLE 1
2	66276400	2	NUT, HEAVY HEX JAM 3/4-10
1	62584422	2	HHCS, 3/8-16 X 1.00"

CLIPPER
SEPARATION
TECHNOLOGIES
SINCE 1869

DIVISION OF
A.T. FERRELL COMPANY
 1440 S ADAMS ST
 BLUFFTON, INDIANA
 46714 - USA
 PH: 260-824-3400
 FAX: 260-824-5463

This drawing is the property of the A.T. Ferrell Company, Inc and must be returned immediately upon request. No part of this drawing may be reproduced, stored in a retrieval system or transmitted in any form or by any means, without prior written consent of the A.T. Ferrell Company, Inc.

TOLERANCES EXCEPT AS NOTED:	TITLE:
DECIMAL: .XX ± .000	SHOE ASSY, TOP W/ROCKERS, 298D
FRACTIONAL: .XXX ± .005	
ANGULAR: ± 1/2°	
FINISH: NONE	
SCALE: 0.16:1	SHEET: 1 OF 3
SIZE: D	PART NUMBER: F03000004
CAD NO MANUAL CHANGES	REV: B

NOTES:
 1. DO NOT SCALE FROM DRAWING.

REVISION HISTORY				
REV	ECN	DESCRIPTION	DATE	APPROVED
A	XXXXXX	RELEASE	3/20/1951	RH
B	F130043	REDRAWN CAD, WAS GROUP DRAWING, BOM WAS BUILD-THRU, ADD F03401700	3/28/2013	dmjohnson

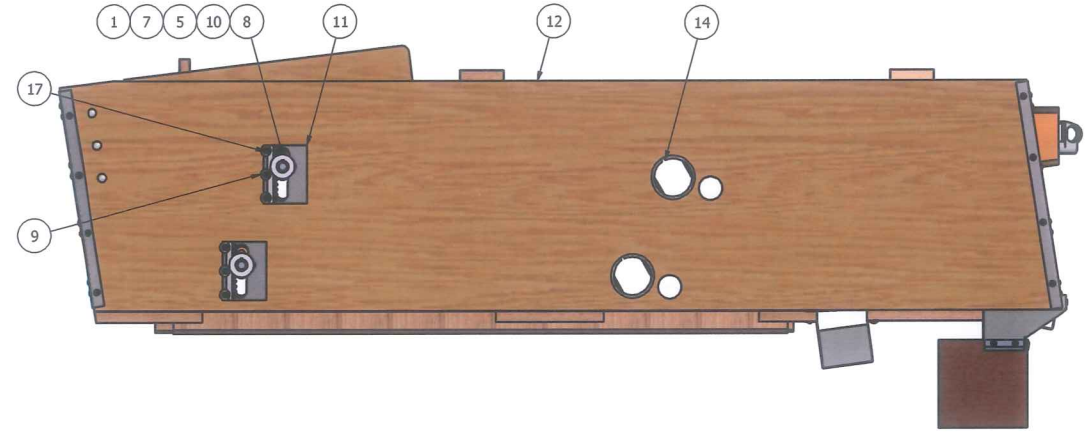

LEFT SIDE VIEW, TOP ROCKER INSTALLATION



SCALE 1/8

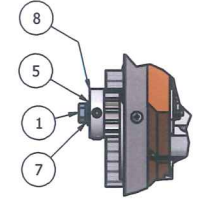

DETAIL C
SCALE 0.31 : 1

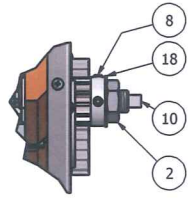

DETAIL D
SCALE 0.31 : 1

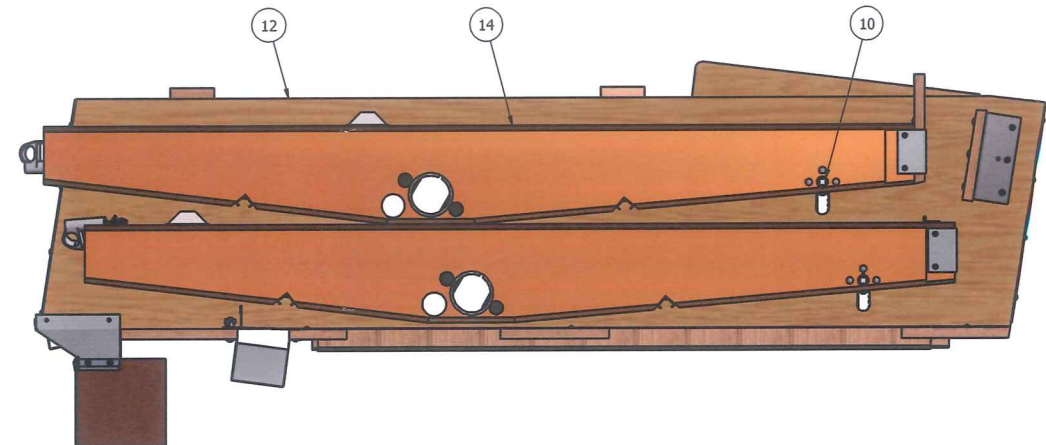

RIGHT SIDE CUTAWAY

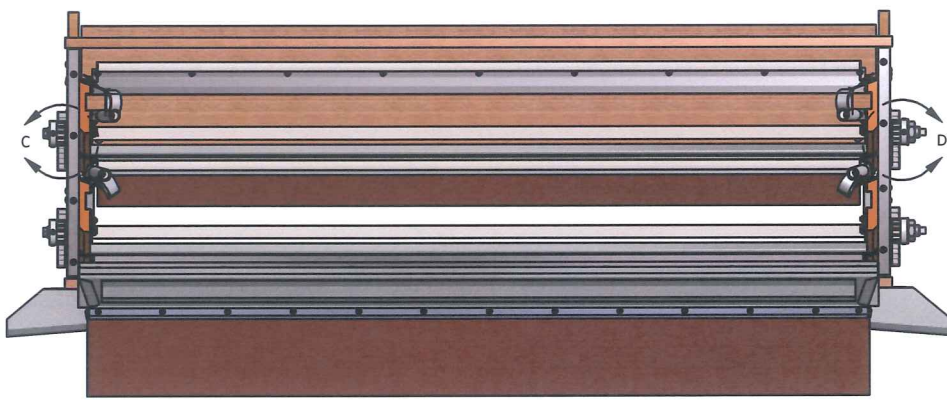

FRONT VIEW, RH ARRANGEMENT SHOWN
F01608303 MAY BE FLIPPED FOR LH ARRANGEMENT
ASSEMBLE PINION COMPONENTS OPPOSITE

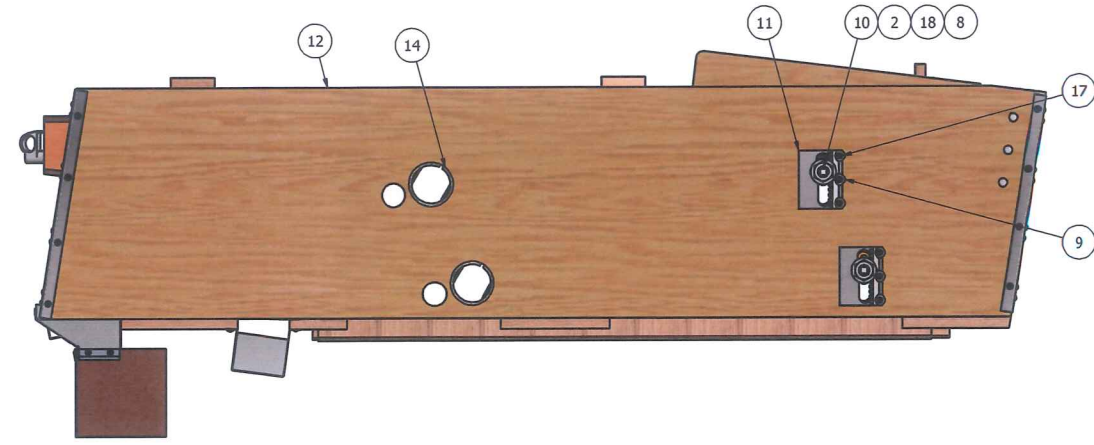

STEP 2: RIGHT SIDE VIEW, TOP ROCKER INSTALLATION

ITEM	PART NUMBER	QTY	DESCRIPTION
19	SALES ORDER	2	FRAME ASSY, PERF SCREEN, 60" X #8
18	F84621034	2	WASHER, FLT .750 X 1.750 X .062
17	F83450101	12	SMS, PAN X HD, #8 X 1.00"
16	F82071401	2	STUD, DOWEL 1/4-20 X 2.50"
15	F03500110	1	ROCKER ASSY, BOTTOM, TOP SHOE, 298D
14	F03500010	1	ROCKER ASSY, TOP, TOP SHOE, 298D
13	F03401700	1	APRON ASSY, 1.25 X 57.5", SEED #8
12	F03000002	1	SHOE ASSY, TOP, 298D
11	F01801700	4	PLATE, ESCUTHCHEON, TILT ROD ROCKER
10	F01608303	2	SHAFT, TILTING ROD, 3/4 X 60.50" #8
9	F01200300	4	RACK, STRAIGHT ROCKER ADJUSTING
8	F01200203	4	PINION, BRUSH ADJ. 13 TOOTH W/SET SCREWS
7	66444400	2	WASHER, LOCK HELICAL 3/8"
6	66443300	2	WASHER, LOCK HELICAL 1/4"
5	66404400	2	WASHER, FLAT 3/8" NARROW TYPE A
4	66403300	2	WASHER, FLAT 1/4"
3	66363300	2	NUT, WING 1/4-20 TYPE B STYLE 1
2	66276400	2	NUT, HEAVY HEX JAM 3/4-10
1	62584422	2	HHCS, 3/8-16 X 1.00"



CLIPPER
SEPARATION
TECHNOLOGIES
SINCE 1989

DIVISION OF
A.T. FERRELL COMPANY
 1440 S ADAMS ST
 BLUFFTON, INDIANA
 46714 - USA
 PH: 260-824-3400
 FAX: 260-824-5463

This drawing is the property of the A.T. Ferrell Company, Inc and must be returned immediately upon request.
 No part of this drawing may be reproduced, stored in a retrieval system or transmitted in any form or by any means, without prior written consent of the A.T. Ferrell Company, Inc.

TOLERANCES EXCEPT AS NOTED:		TITLE: SHOE ASSY, TOP W/ROCKERS, 298D	
DECIMAL:	FRACTIONAL:	FINISH:	
XX ± .030	± 1/32	NONE	
XXX ± .005	ANGULAR: ± 1/2°		
XXXX ± .001			
CAD NO MANUAL CHANGES	SCALE: 0.16:1	SHEET: 2 OF 3	SIZE: D PART NUMBER: F03000004
			REV: B

NOTES:
1. DO NOT SCALE FROM DRAWING.

REVISION HISTORY				
REV	ECN	DESCRIPTION	DATE	APPROVED
A	XXXXXX	RELEASE	3/20/1951	RH
B	F130043	REDRAWN CAD, WAS GROUP DRAWING, BOM WAS BUILD-THRU, ADD F03401700	3/28/2013	dmjohnson

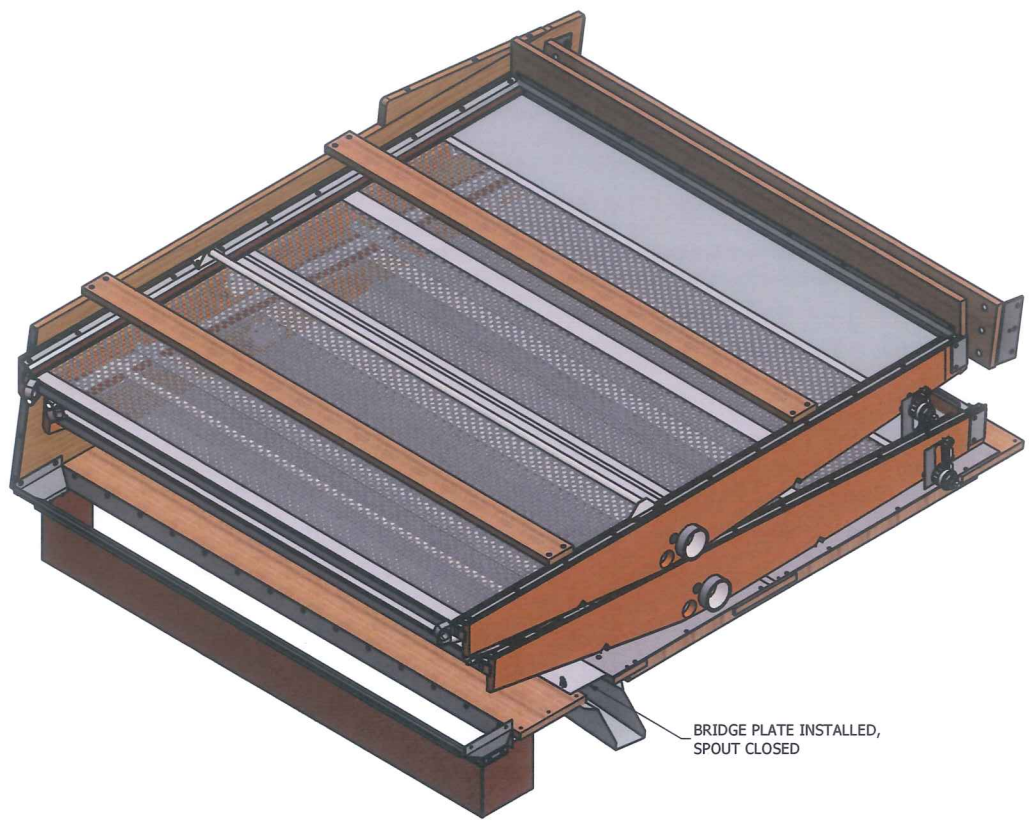

RIGHT SIDE CUTAWAY, BOTTOM ROCKER SCALP FLOW ARRANGEMENT
 SCALE 1/8
 BOTTOM ROCKER SHOWN AT MINIMUM PITCH

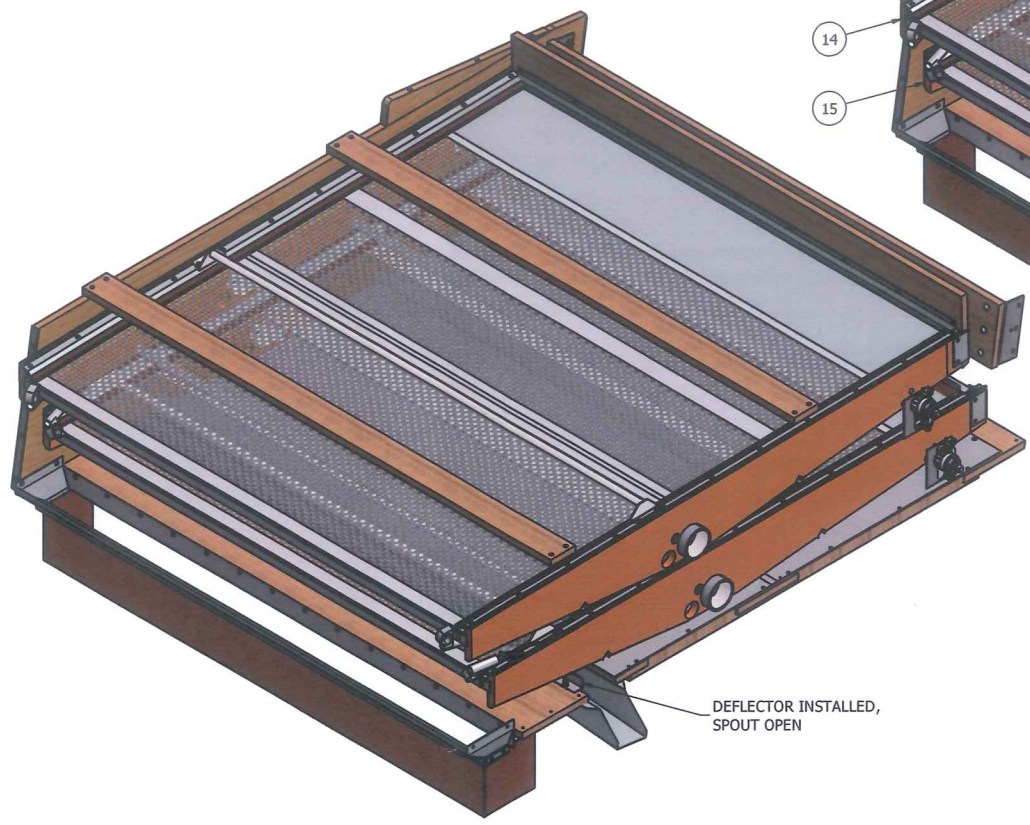

RIGHT SIDE CUTAWAY, BOTTOM ROCKER SIFT FLOW ARRANGEMENT
 SCALE 1/8
 TOP ROCKER SHOWN AT MAXIMUM PITCH

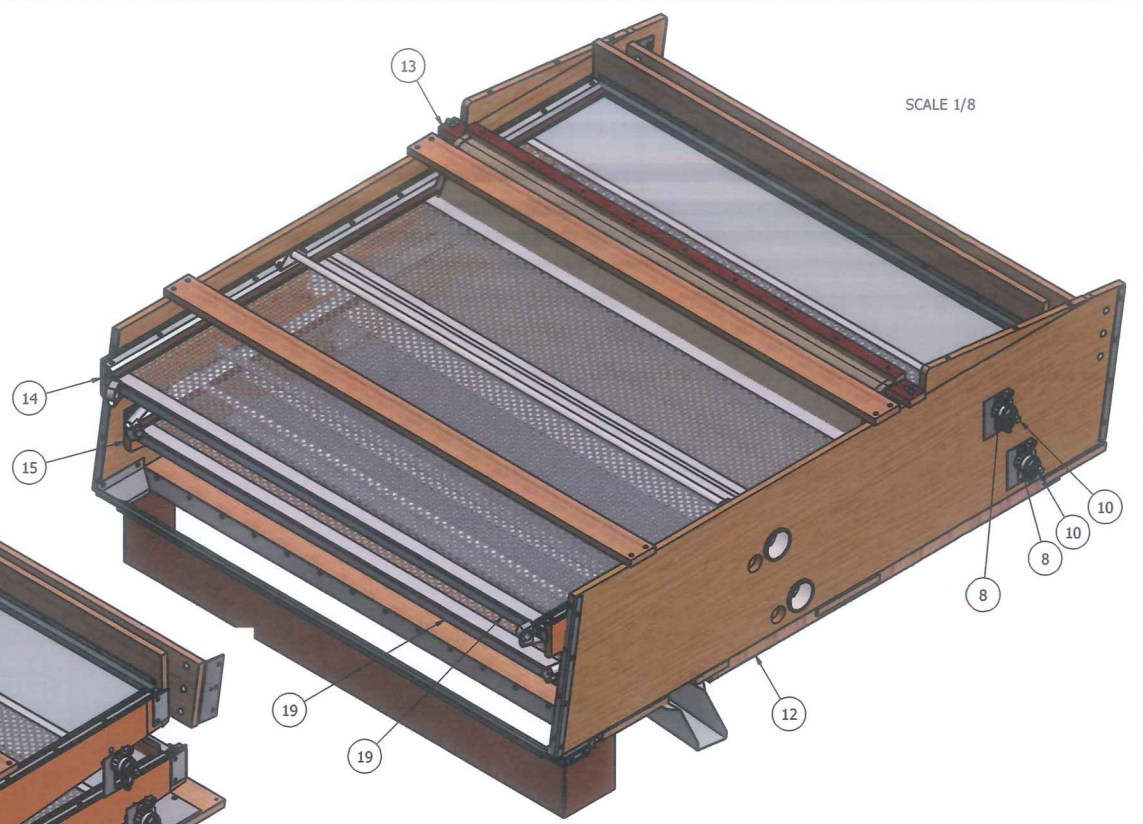

SCALE 1/8

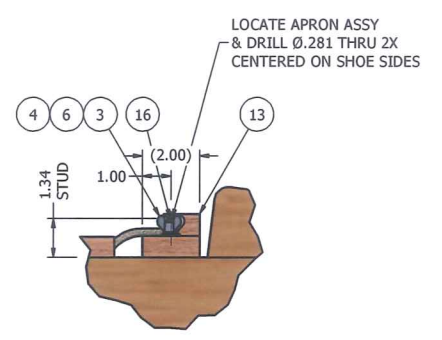

DETAIL E
 SCALE 0.31 : 1

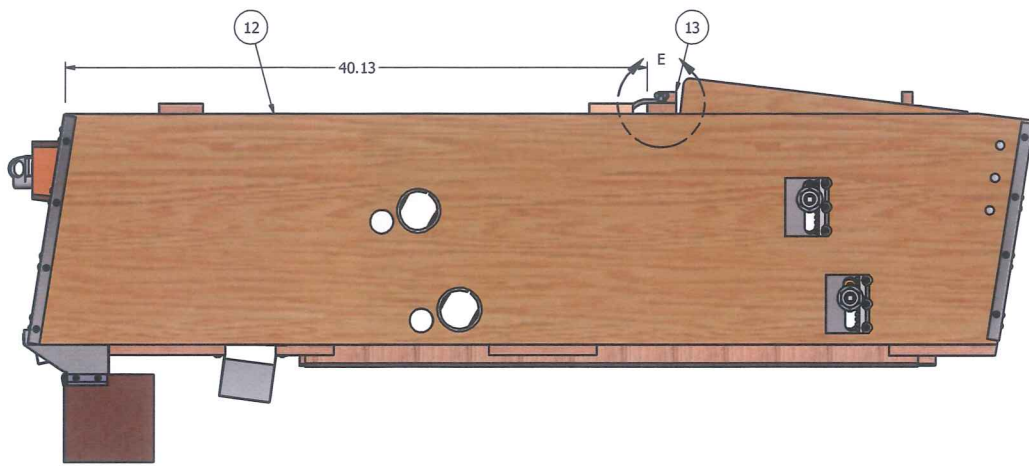
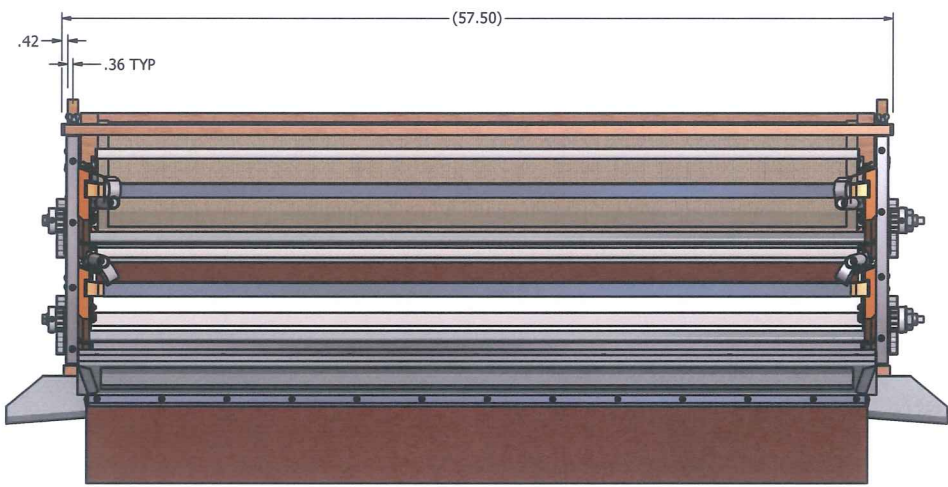

RIGHT SIDE VIEW, COMPLETE ASSEMBLY

ITEM	PART NUMBER	QTY	DESCRIPTION
19	SALES ORDER	2	FRAME ASSY, PERF SCREEN, 60" X #8
18	F84621034	2	WASHER, FLT .750 X 1.750 X .062
17	F83450101	12	SMS, PAN X HD, #8 X 1.00"
16	F82071401	2	STUD, DOWEL 1/4-20 X 2.50"
15	F03500110	1	ROCKER ASSY, BOTTOM, TOP SHOE, 298D
14	F03500010	1	ROCKER ASSY, TOP, TOP SHOE, 298D
13	F03401700	1	APRON ASSY, 1.25 X 57.5", SEED #8
12	F03000002	1	SHOE ASSY, TOP, 298D
11	F01801700	4	PLATE, ESCUTCHION, TILT ROD ROCKER
10	F01608303	2	SHAFT, TILTING ROD, 3/4 X 60.50" #8
9	F01200300	4	RACK, STRAIGHT ROCKER ADJUSTING
8	F01200203	4	PINION, BRUSH ADJ. 13 TOOTH W/SET SCREWS
7	66444400	2	WASHER, LOCK HELICAL 3/8"
6	66443300	2	WASHER, LOCK HELICAL 1/4"
5	66404400	2	WASHER, FLAT 3/8" NARROW TYPE A
4	66403300	2	WASHER, FLAT 1/4"
3	66363300	2	NUT, WING 1/4-20 TYPE B STYLE 1
2	66276400	2	NUT, HEAVY HEX JAM 3/4-10
1	62584422	2	HHCS, 3/8-16 X 1.00"

CLIPPER
 SEPARATION TECHNOLOGIES
 SINCE 1869

DIVISION OF
 A.T. FERRELL COMPANY
 1440 S ADAMS ST
 BLUFFTON, INDIANA
 46714 - USA
 PH: 260-824-3400
 FAX: 260-824-5483

This drawing is the property of the A.T. Ferrell Company, Inc. and must be returned immediately upon request. No part of this drawing may be reproduced, stored in a retrieval system or transmitted in any form or by any means, without prior written consent of the A.T. Ferrell Company, Inc.

DRAWN BY: dmjohnson
 DRAWN DATE: 3/28/2013
 APPROVED BY: DMJ

TOLERANCES EXCEPT AS NOTED:	TITLE
DECIMAL: ± .030	SHOE ASSY, TOP W/ROCKERS, 298D
FRACTIONAL: ± 1/32	
ANGULAR: ± 1/2°	
FINISH: NONE	
NO MANUAL CHANGES	
SCALE: 0.16:1	SHEET: 3 OF 3
SIZE: D	PART NUMBER: F03000004
REV: B	

NOTES:
 1. DO NOT SCALE FROM DRAWING.