

REV	ECN	REVISION HISTORY	DATE	APPROVED
A	XXXXXX	RELEASE	5/9/1957	DR
B	F120091	REDRAWN CAD, WAS C SIZE GROUP DRAWING	9/12/2012	dmjohnson
C	F130052	ROTATE ROCKER CUPS 30 DEG	4/5/2013	dmjohnson

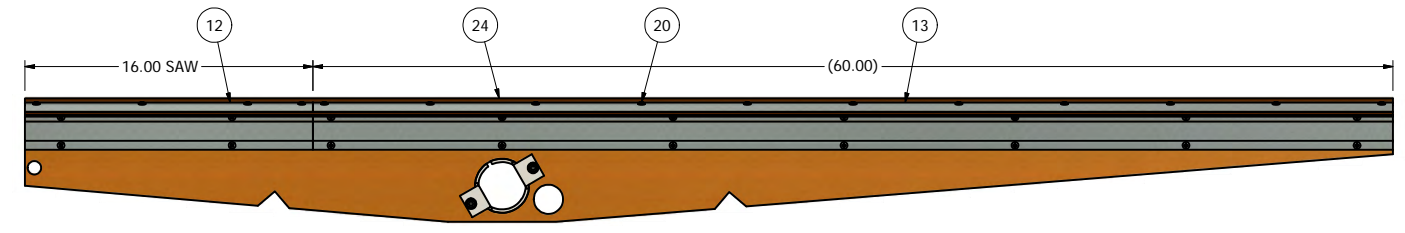

STEP 2: RIGHT ROCKER SIDE ASSEMBLY, LEFT SIDE VIEW
 TYPICAL ASSEMBLY FOR LEFT ROCKER SIDE

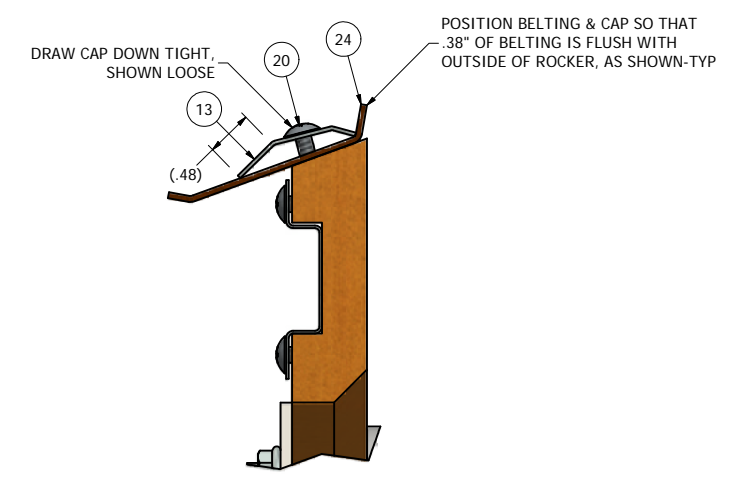

DETAIL B
 SCALE 1:1

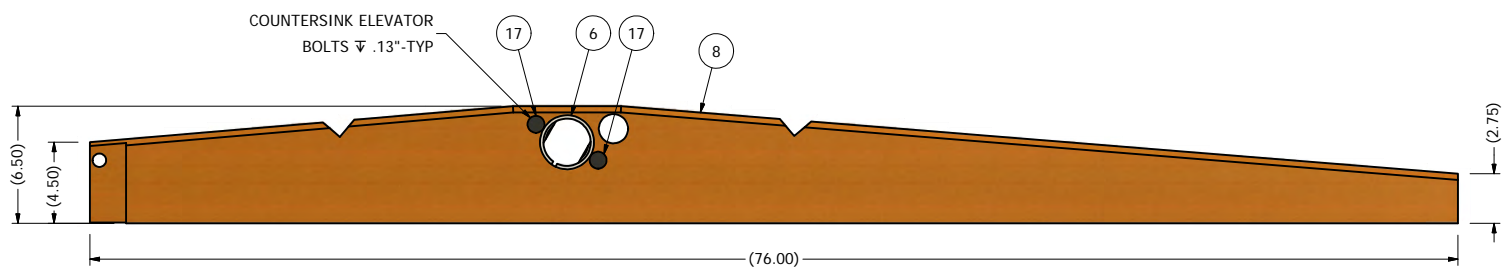

STEP 1: RIGHT ROCKER SIDE ASSEMBLY, LEFT SIDE VIEW
 TYPICAL ASSEMBLY FOR LEFT ROCKER SIDE

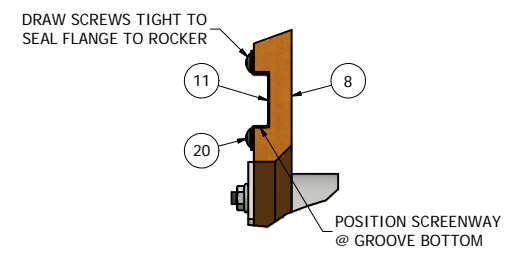

DETAIL A
 SCALE 1/2

ITEM	PART NUMBER	QTY	DESCRIPTION
24	F91152006	13.000 ft	BELTING, 3 PLY FSXFS 2.50 X 78.00"
23	F90005304	1	GIRT WLDMT, ROCKER ADJ, TELESCOPING, #9
22	F84212122	8	SMS, FLT X HD #8 X 3/4"
21	F83453403	4	SMS, PAN X HD, #10 X 3/4"
20	F83453402	68	SMS, PAN X HD, #8 X 3/4"
19	F83451201	5	SMS, PAN X HD, #8 X 1/2"
18	F83440301	4	SMS, FLAT CROSS HEAD #10 X 1.50"
17	F82021407	4	BOLT, ELEV 1/4-20 X 1.25"
16	F11302511	1	COVER, APRON, ADJ GIRT, ROCKER, #9
15	F03806000	2	ANGLE, SCREEN STOP, ROCKER
14	F03803300	1	BLANK ASSY, TOP/BTM ROCKER, BTM SHOE, SX29D
13	F03801100	2	CAP, RUBBER HOLDING, ROCKER, 60.00"
12	F03801100	2	CAP, RUBBER HOLDING, ROCKER, 16.00"
11	F03800412	2	LINER WLDMT, SCREENWAY, ROCKER, 76.00"
10	F03800001	2	BRACE, BOTTOM, ROCKER, #9
9	F03601505	1	SIDE, LH, BTM ROCKER 76", BTM SHOE, SX29D/SX298D
8	F03601504	1	SIDE, RH, BTM ROCKER 76", BTM SHOE, SX29D/SX298D
7	F03500800	2	SCREEN HOOK ASSY, STANDARD
6	F03500600	2	CUP WLDMT, ROCKER, HEAVY DUTY BRUSH
5	F03310008	1	GRAIN STOP ASSY, ROCKER, 2.50" X #9
4	66783300	4	NUT, HEX SERR LOCK 1/4-20
3	66782600	4	NUT, HEX SERR LOCK 10-24
2	66402200	5	WASHER, FLAT, #8
1	60282626	4	BOLT, CARR 10-24 X 1.25"

- NOTES:
- DO NOT SCALE FROM DRAWING.
 - ONE PIECE REQUIRED PER F03013206/07: SHOE ASSY, RH/LH ADJ PITCH BOTTOM, SX29D.
 - TWO PIECES REQUIRED PER F03018405/06: SHOE ASSY, RH/LH ADJ PITCH BOTTOM, SX2969D.

CLIPPER
SEPARATION TECHNOLOGIES
SINCE 1988

DIVISION OF
A.T.FERRELL COMPANY
 1440 S ADAMS ST
 BLUFFTON, INDIANA
 46714 - USA
 PH: 260-824-3400
 FAX: 260-824-5463

This drawing is the property of the A.T. Ferrell Company, Inc and must be returned immediately upon request. No part of this drawing may be reproduced, stored in a retrieval system or transmitted in any form or by any means, without prior written consent of the A.T. Ferrell Company, Inc.

TOLERANCES EXCEPT AS NOTED	TITLE:
DECIMAL: .030	ROCKER ASSY, BOTTOM, BOTTOM SHOE, SX29D
FRACTIONAL: 1/32	
XX ± .030	FINISH:
XXX ± .005	NONE
XXXX ± .001	ANGULAR: ± 1/2"
CAD	NO MANUAL CHANGES
SCALE: 0.19:1	SHEET: 1 OF 3
SIZE: D	PART NUMBER: F03502000
REV: C	

REV	ECN	REVISION HISTORY	DATE	APPROVED
A	XXXXXX	RELEASE	5/9/1957	DR
B	F120091	REDRAWN CAD, WAS C SIZE GROUP DRAWING	9/12/2012	dmjohnson
C	F130052	ROTATE ROCKER CUPS 30 DEG	4/5/2013	dmjohnson

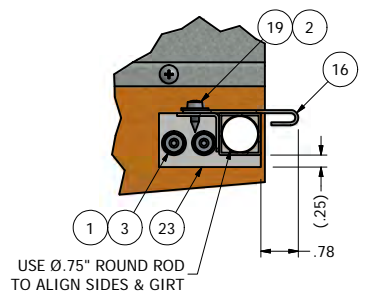
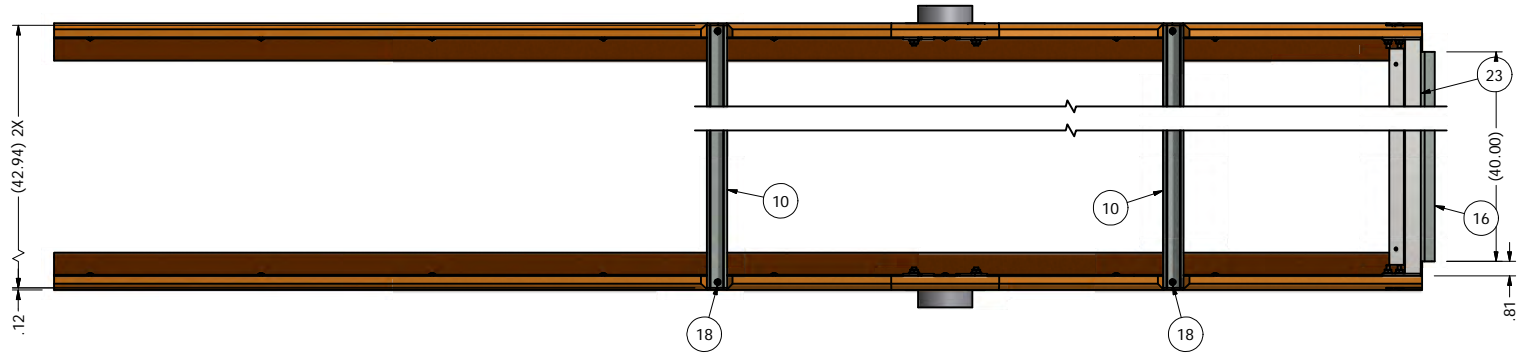

DETAIL D
SCALE 1/2

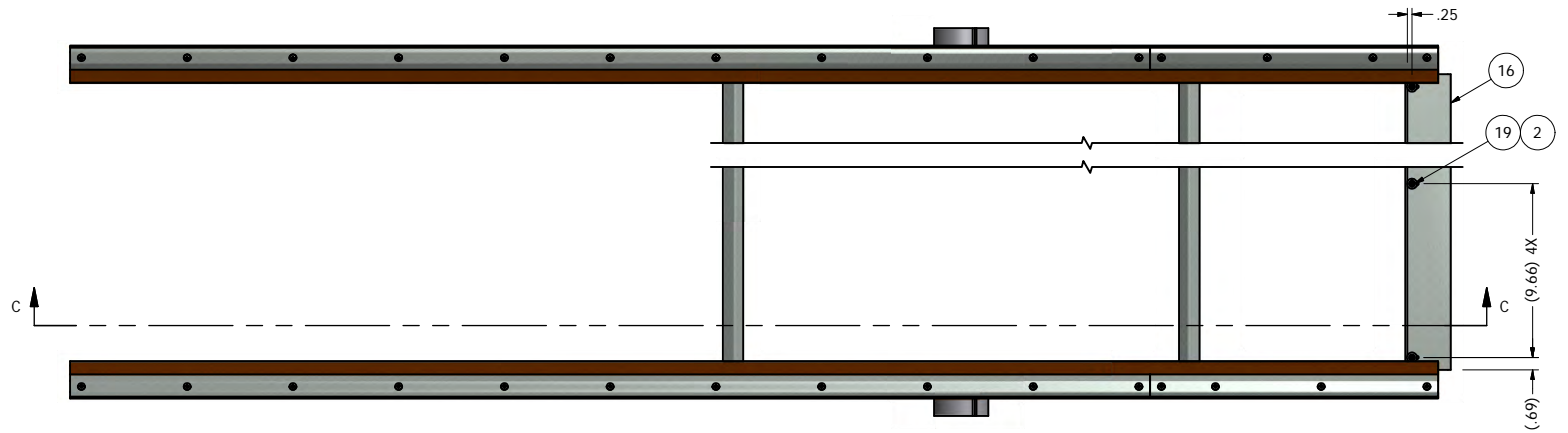
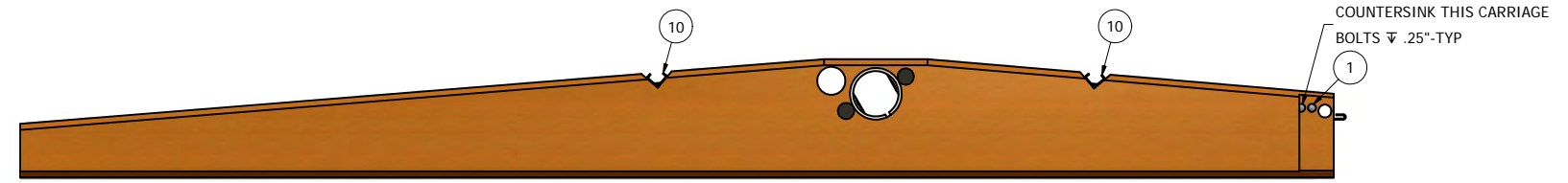
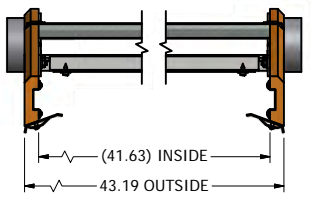

STEP 3: GIRT INSTALLATION, TOP VIEW

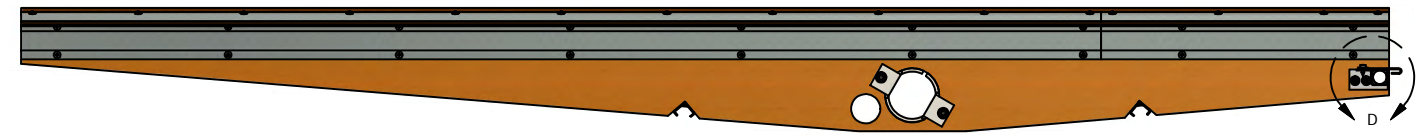

SECTION C-C

ITEM	PART NUMBER	QTY	DESCRIPTION
24	F91152006	13,000 ft	BELTING, 3 PLY FSXFS 2.50 X 78.00"
23	F90005304	1	GIRT WLDMT, ROCKER ADJ, TELESCOPING, #9
22	F84212122	8	SMS, FLT X HD #8 X 3/4"
21	F83453403	4	SMS, PAN X HD, #10 X 3/4"
20	F83453402	68	SMS, PAN X HD, #8 X 3/4"
19	F83451201	5	SMS, PAN X HD, #8 X 1/2"
18	F83440301	4	SMS, FLAT CROSS HEAD #10 X 1.50"
17	F82021407	4	BOLT, ELEV 1/4-20 X 1.25"
16	F11302511	1	COVER, APRON, ADJ GIRT, ROCKER, #9
15	F03806000	2	ANGLE, SCREEN STOP, ROCKER
14	F03803300	1	BLANK ASSY, TOP/BTM ROCKER, BTM SHOE, SX29D
13	F03801100	2	CAP, RUBBER HOLDING, ROCKER, 60.00"
12	F03801100	2	CAP, RUBBER HOLDING, ROCKER, 16.00"
11	F03800412	2	LINER WLDMT, SCREENWAY, ROCKER, 76.00"
10	F03800001	2	BRACE, BOTTOM, ROCKER, #9
9	F03601505	1	SIDE, LH, BTM ROCKER 76", BTM SHOE, SX29D/SX298D
8	F03601504	1	SIDE, RH, BTM ROCKER 76", BTM SHOE, SX29D/SX298D
7	F03500800	2	SCREEN HOOK ASSY, STANDARD
6	F03500600	2	CUP WLDMT, ROCKER, HEAVY DUTY BRUSH
5	F03310008	1	GRAIN STOP ASSY, ROCKER, 2.50" X #9
4	66783300	4	NUT, HEX SERR LOCK 1/4-20
3	66782600	4	NUT, HEX SERR LOCK 10-24
2	66402200	5	WASHER, FLAT, #8
1	60282626	4	BOLT, CARR 10-24 X 1.25"

CLIPPER SEPARATION TECHNOLOGIES
 DIVISION OF
 A.T.FERRELL COMPANY
 1440 S ADAMS ST
 BLUFFTON, INDIANA
 46714 - USA
 PH: 260-824-3400
 FAX: 260-824-5463

This drawing is the property of the A.T. Ferrell Company, Inc and must be returned immediately upon request. No part of this drawing may be reproduced, stored in a retrieval system or transmitted in any form or by any means, without prior written consent of the A.T. Ferrell Company, Inc.

DRAWN BY: dmjohnson
 DRAWN DATE: 9/12/2012
 APPROVED BY: DMJ

TOLERANCES EXCEPT AS NOTED	TITLE:
DECIMAL: XX ± .030	ROCKER ASSY, BOTTOM, BOTTOM SHOE, SX29D
FRACTIONAL: XXX ± .005	FINISH:
ANGULAR: XXXX ± .001	NONE
CAD NO MANUAL CHANGES	SCALE: 0.19:1
	SHEET: 2 OF 3
	SIZE: D
	PART NUMBER: F03502000
	REV: C

- NOTES:
 1. DO NOT SCALE FROM DRAWING.
 2. ONE PIECE REQUIRED PER F03013206/07: SHOE ASSY, RH/LH ADJ PITCH BOTTOM, SX29D.
 3. TWO PIECES REQUIRED PER F03018405/06: SHOE ASSY, RH/LH ADJ PITCH BOTTOM, SX2969D.

REVISION HISTORY				
REV	ECN	DESCRIPTION	DATE	APPROVED
A	XXXXXX	RELEASE	5/9/1957	DR
B	F120091	REDRAWN CAD, WAS C SIZE GROUP DRAWING	9/12/2012	dmjohnson
C	F130052	ROTATE ROCKER CUPS 30 DEG	4/5/2013	dmjohnson

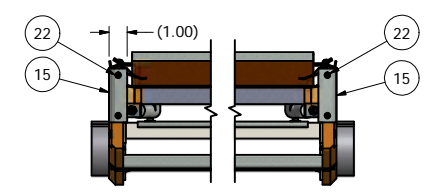
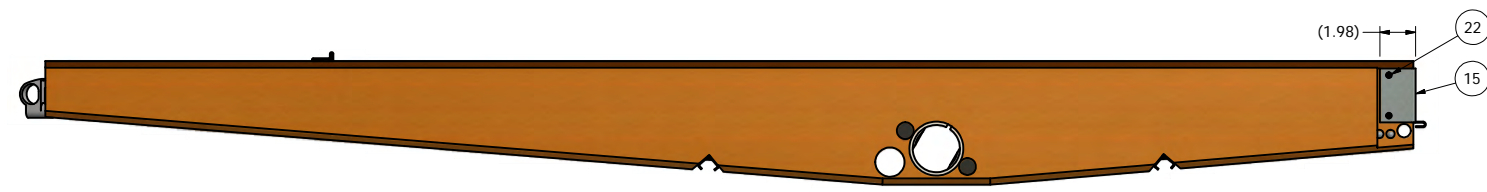
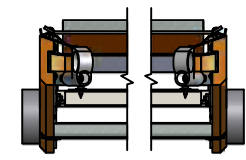
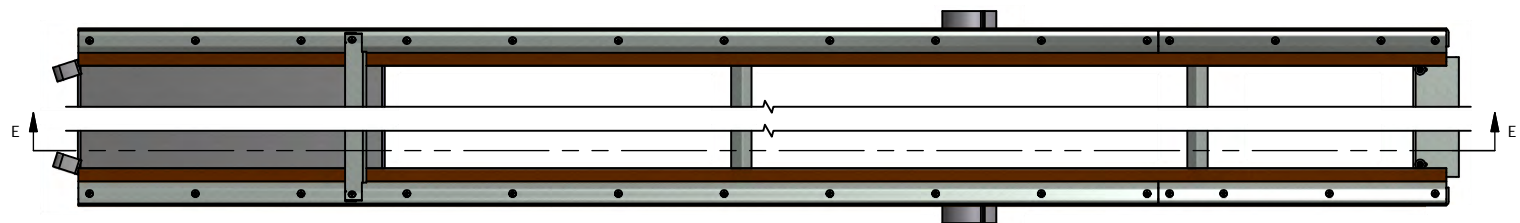

STEP 4: COMPLETE ASSEMBLY, RIGHT SIDE VIEW

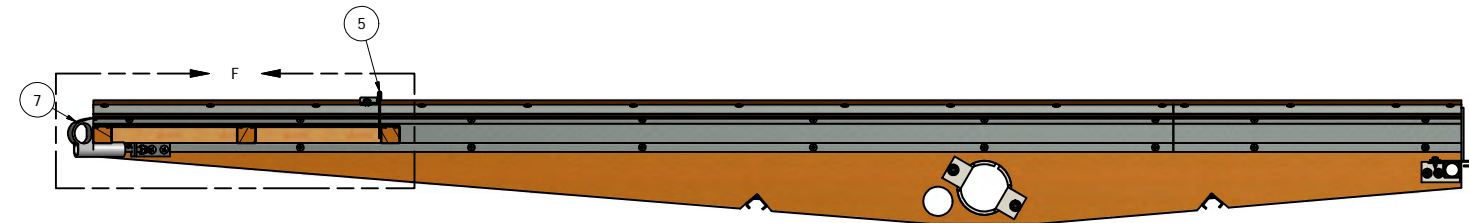

SECTION E-E

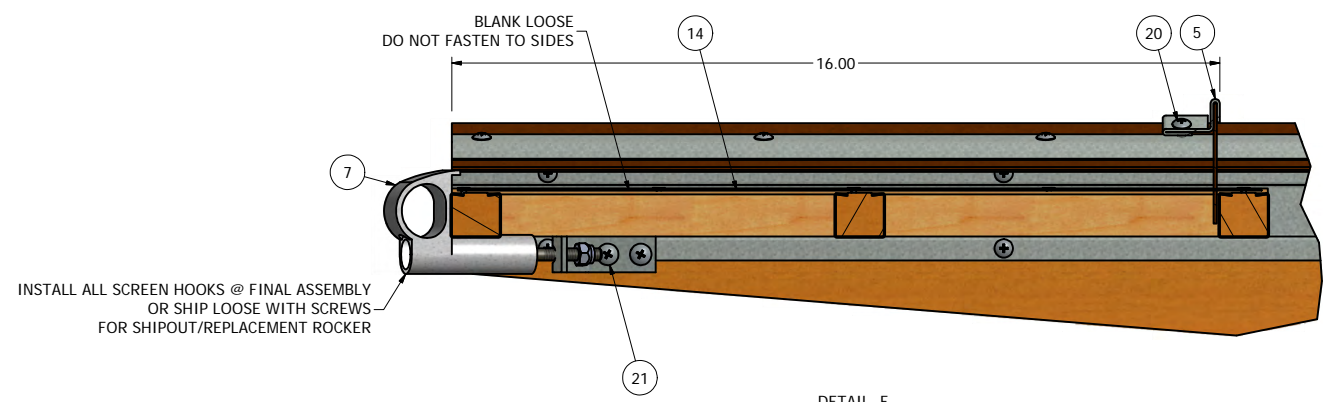

DETAIL F
SCALE 1/2

ITEM	PART NUMBER	QTY	DESCRIPTION
24	F91152006	13.000 ft	BELTING, 3 PLY FSXFS 2.50 X 78.00"
23	F90005304	1	GIRT WLDMT, ROCKER ADJ, TELESCOPING, #9
22	F84212122	8	SMS, FLT X HD #8 X 3/4"
21	F83453403	4	SMS, PAN X HD, #10 X 3/4"
20	F83453402	68	SMS, PAN X HD, #8 X 3/4"
19	F83451201	5	SMS, PAN X HD, #8 X 1/2"
18	F83440301	4	SMS, FLAT CROSS HEAD #10 X 1.50"
17	F82021407	4	BOLT, ELEV 1/4-20 X 1.25"
16	F11302511	1	COVER, APRON, ADJ GIRT, ROCKER, #9
15	F03806000	2	ANGLE, SCREEN STOP, ROCKER
14	F03803300	1	BLANK ASSY, TOP/BTM ROCKER, BTM SHOE, SX29D
13	F03801100	2	CAP, RUBBER HOLDING, ROCKER, 60.00"
12	F03801100	2	CAP, RUBBER HOLDING, ROCKER, 16.00"
11	F03800412	2	LINER WLDMT, SCREENWAY, ROCKER, 76.00"
10	F03800001	2	BRACE, BOTTOM, ROCKER, #9
9	F03601505	1	SIDE, LH, BTM ROCKER 76", BTM SHOE, SX29D/SX298D
8	F03601504	1	SIDE, RH, BTM ROCKER 76", BTM SHOE, SX29D/SX298D
7	F03500800	2	SCREEN HOOK ASSY, STANDARD
6	F03500600	2	CUP WLDMT, ROCKER, HEAVY DUTY BRUSH
5	F03310008	1	GRAIN STOP ASSY, ROCKER, 2.50" X #9
4	66783300	4	NUT, HEX SERR LOCK 1/4-20
3	66782600	4	NUT, HEX SERR LOCK 10-24
2	66402200	5	WASHER, FLAT, #8
1	60282626	4	BOLT, CARR 10-24 X 1.25"

CLIPPER
SEPARATION TECHNOLOGIES

DIVISION OF
A.T.FERRELL COMPANY
1440 S ADAMS ST
BLUFFTON, INDIANA
46714 - USA
PH: 260-824-3400
FAX: 260-824-5463

This drawing is the property of the A.T. Ferrell Company, Inc and must be returned immediately upon request. No part of this drawing may be reproduced, stored in a retrieval system or transmitted in any form or by any means, without prior written consent of the A.T. Ferrell Company, Inc.

TOLERANCES EXCEPT AS NOTED		TITLE:	
DECIMAL: .030	FRACTIONAL: 1/32	ROCKER ASSY, BOTTOM, BOTTOM SHOE, SX29D	
XX ± .030	XXX ± .005	FINISH:	
XXXX ± .001	ANGULAR: ± 1/2°	NONE	
CAD NO MANUAL CHANGES		SCALE: 0.19:1	SHEET: 3 OF 3
		SIZE: D	PART NUMBER: F03502000
		REV: C	

- NOTES:
- DO NOT SCALE FROM DRAWING.
 - ONE PIECE REQUIRED PER F03013206/07: SHOE ASSY, RH/LH ADJ PITCH BOTTOM, SX29D.
 - TWO PIECES REQUIRED PER F03018405/06: SHOE ASSY, RH/LH ADJ PITCH BOTTOM, SX2969D.