

REV	ECN	REVISION HISTORY	DATE	APPROVED
A	XXXXXX	RELEASE	5/9/1957	DR
B	F120091	WAS C SIZE GROUP DRAWING, F03803301, -6000 & F90005100 WAS F10512601, F03803400 & F90005300	10/5/2012	dmjohnson
C	F130052	ROTATE ROCKER CUPS 30 DEG	4/5/2013	dmjohnson

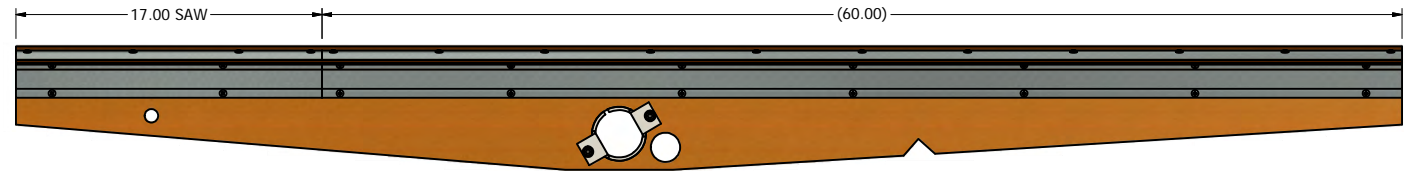

STEP 2: RIGHT ROCKER SIDE ASSEMBLY, LEFT SIDE VIEW
 TYPICAL ASSEMBLY FOR LEFT ROCKER SIDE

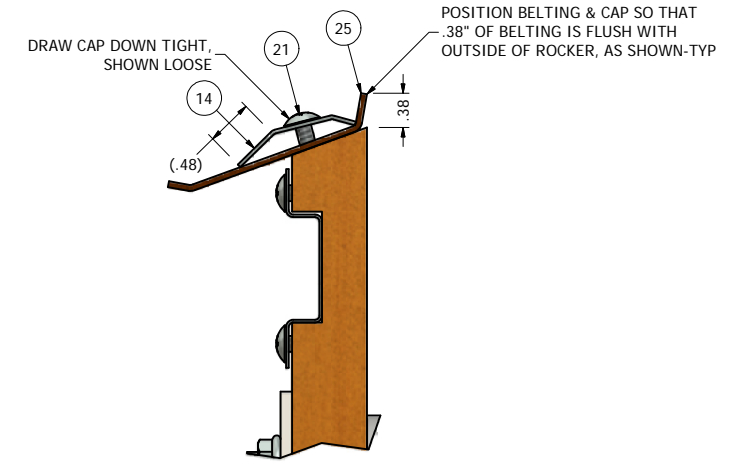

DETAIL B
 SCALE 1:1

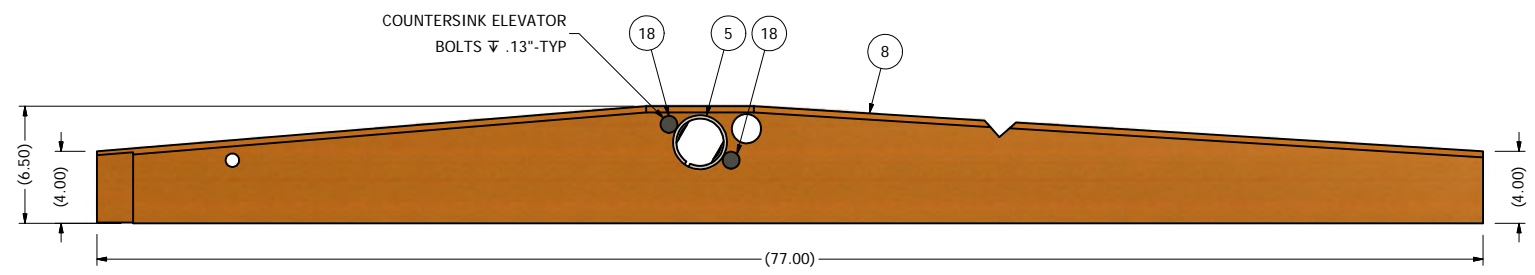

STEP 1: RIGHT ROCKER SIDE ASSEMBLY, LEFT SIDE VIEW
 TYPICAL ASSEMBLY FOR LEFT ROCKER SIDE

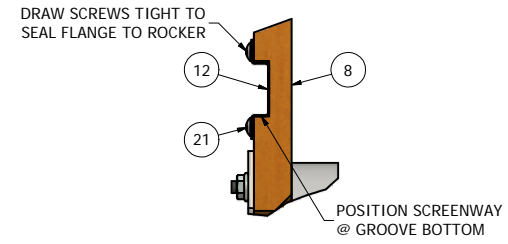

DETAIL A
 SCALE 1/2

ITEM	PART NUMBER	QTY	DESCRIPTION
25	F91152006	13.167 ft	BELTING, 3 PLY FSXFS 2.50 X 79.00"
24	F90005100	1	GIRT WLDMT, ROCKER ADJUSTMENT, CENTERED, #8
23	F84212122	4	SMS, FLT X HD #8 X 3/4"
22	F83453403	4	SMS, PAN X HD, #10 X 3/4"
21	F83453402	86	SMS, PAN X HD, #8 X 3/4"
20	F83451201	11	SMS, PAN X HD, #8 X 1/2"
19	F83440301	2	SMS, FLAT CROSS HEAD #10 X 1.50"
18	F82021407	4	BOLT, ELEV 1/4-20 X 1.25"
17	F03806000	2	ANGLE, SCREEN STOP, ROCKER
16	F03803501	1	BOTTOM METAL ASSY, TOP ROCKER, TOP SHOE, SX298D
15	F03803301	1	BLANK ASSY, TOP ROCKER, BTM SHOE, SX298D
14	F03801100	2	CAP, RUBBER HOLDING, ROCKER, 60.00"
13	F03801100	2	CAP, RUBBER HOLDING, ROCKER, 17.00"
12	F03800401	2	LINER WLDMT, SCREENWAY, ROCKER, 77.00"
11	F03800002	1	BRACE, BOTTOM, ROCKER, #8
10	F03601610	1	BOARD, REAR CROSS, TOP ROCKER, TOP SHOE, SX298D
9	F03601402	1	SIDE, LH, TOP ROCKER, TOP SHOE, SX29D/SX298D
8	F03601400	1	SIDE, RH, TOP ROCKER, TOP SHOE, SX29D/SX298D
7	F03505800	1	GIRT WLDMT, PIPE, ROCKER #8
6	F03500800	2	SCREEN HOOK ASSY, STANDARD
5	F03500600	2	CUP WLDMT, ROCKER, HEAVY DUTY BRUSH
4	66783300	4	NUT, HEX SERR LOCK 1/4-20
3	66782600	6	NUT, HEX SERR LOCK 10-24
2	65852226	4	SMS, FLT X HD #8 X 1.25"
1	60282626	6	BOLT, CARR 10-24 X 1.25"

NOTES:
 1. DO NOT SCALE FROM DRAWING.
 2. ONE PIECE REQUIRED PER F03013304/07: SHOE ASSY, RH/LH TOP W/ ROCKERS, SX298D.



CLIPPER
SEPARATION TECHNOLOGIES
SINCE 1988

DIVISION OF
A.T.FERRELL COMPANY
 1440 S ADAMS ST
 BLUFFTON, INDIANA
 46714 - USA
 PH: 260-824-3400
 FAX: 260-824-5463

This drawing is the property of the A.T. Ferrell Company, Inc and must be returned immediately upon request. No part of this drawing may be reproduced, stored in a retrieval system or transmitted in any form or by any means, without prior written consent of the A.T. Ferrell Company, Inc.

TOLERANCES EXCEPT AS NOTED	TITLE:
DECIMAL: .030	ROCKER ASSY, TOP, TOP SHOE, SX298D
FRACTIONAL: 1/32	
XX ± .030	FINISH:
XXX ± .005	NONE
XXXX ± .001	ANGULAR: ± 1/2°
CAD	NO MANUAL CHANGES
SCALE: 0.19:1	SHEET: 1 OF 3
SIZE: D	PART NUMBER: F03502110
REV: C	

REV	ECN	REVISION HISTORY	DATE	APPROVED
A	XXXXXX	RELEASE	5/9/1957	DR
B	F120091	WAS C SIZE GROUP DRAWING, F03803301, -6000 & F90005100 WAS F10512601, F03803400 & F90005300	10/5/2012	dmjohnson
C	F130052	ROTATE ROCKER CUPS 30 DEG	4/5/2013	dmjohnson

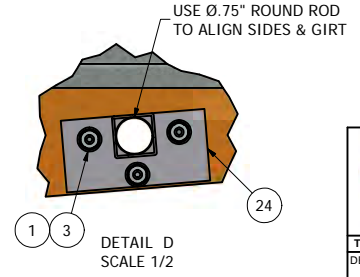
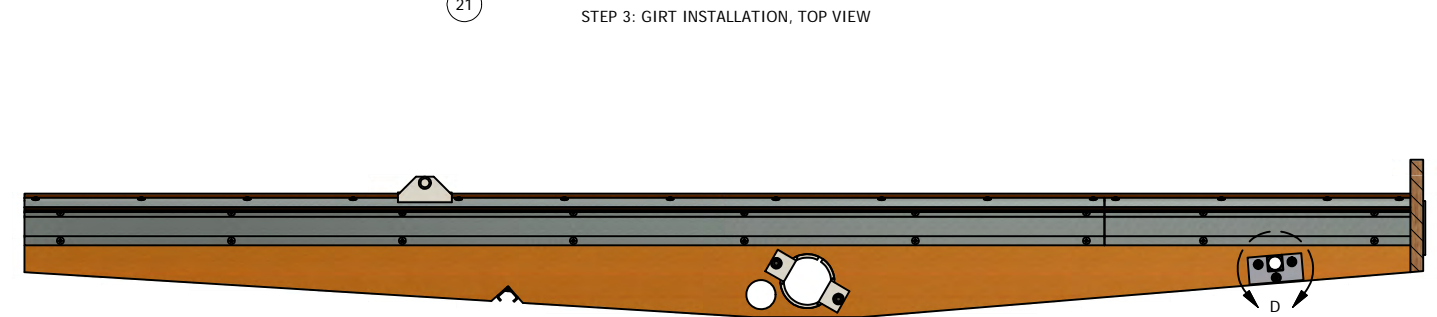
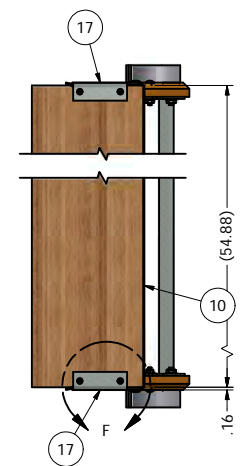
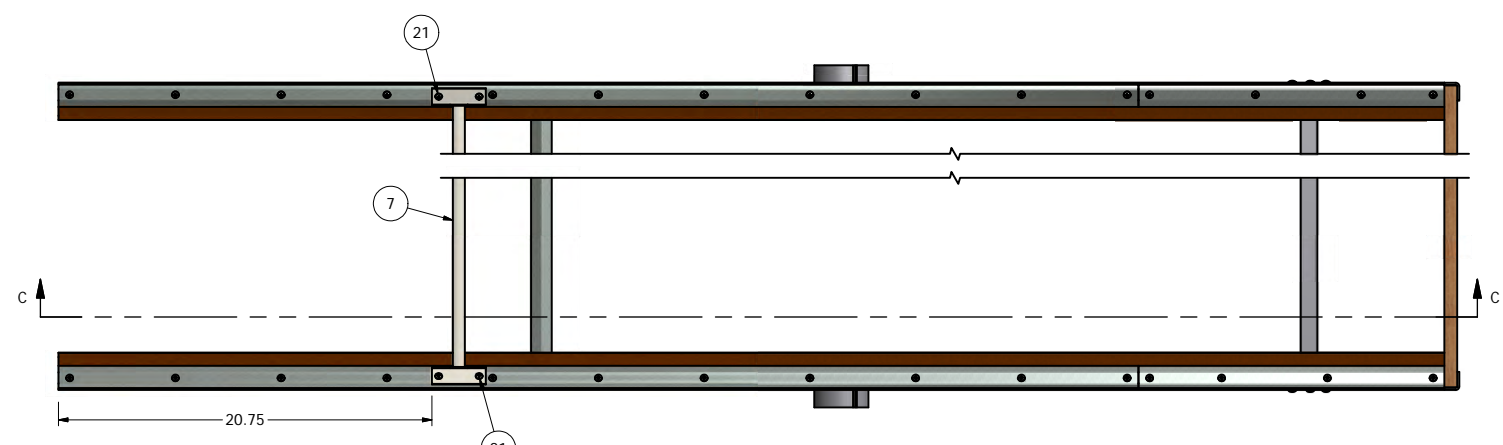
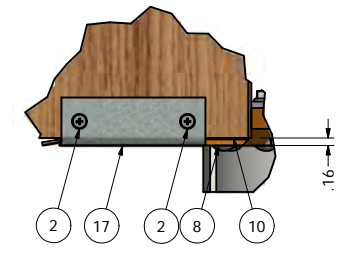
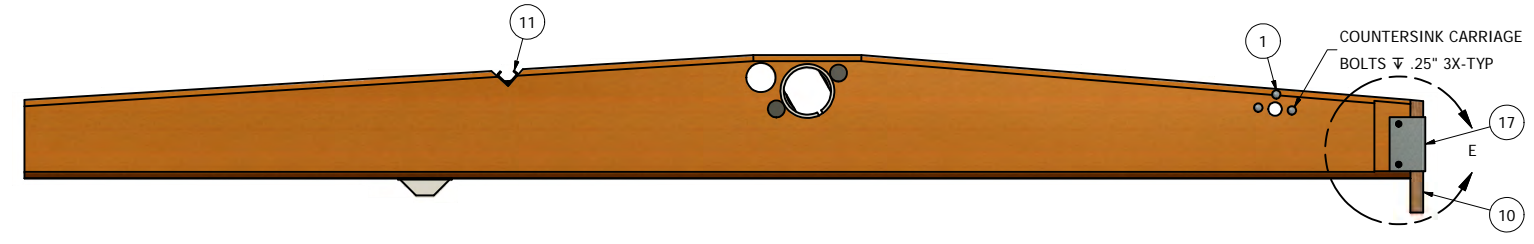
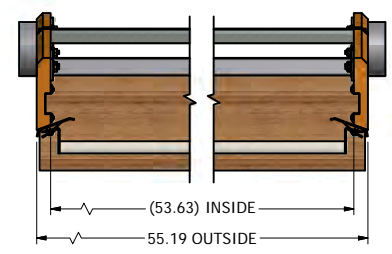
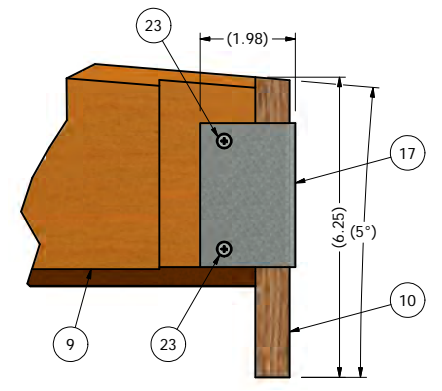
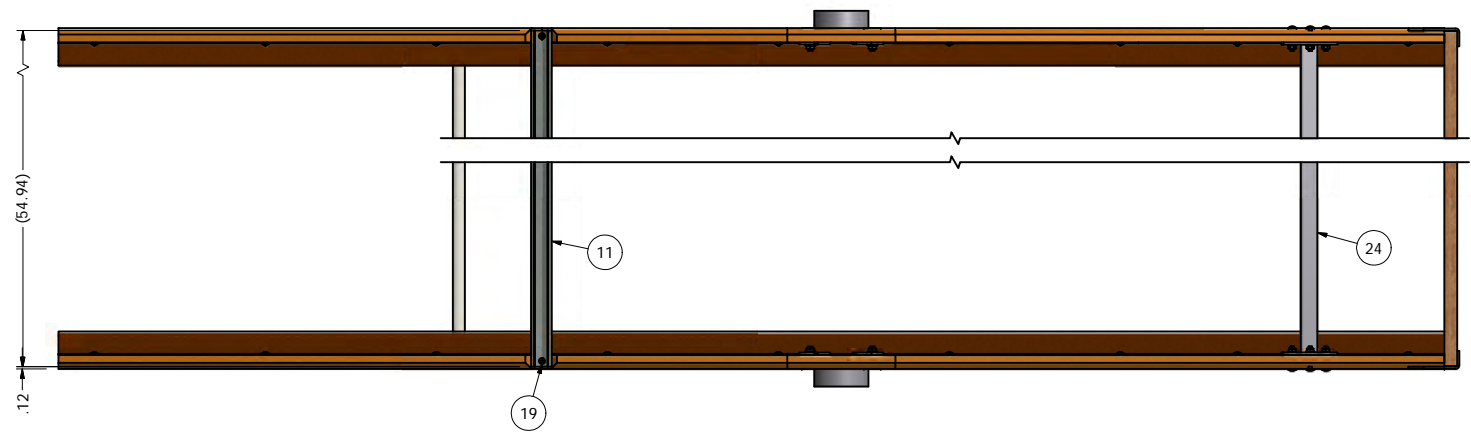

ITEM	PART NUMBER	QTY	DESCRIPTION
25	F91152006	13.167 ft	BELTING, 3 PLY FSXFS 2.50 X 79.00"
24	F90005100	1	GIRT WLDMT, ROCKER ADJUSTMENT, CENTERED, #8
23	F84212122	4	SMS, FLT X HD #8 X 3/4"
22	F83453403	4	SMS, PAN X HD, #10 X 3/4"
21	F83453402	86	SMS, PAN X HD, #8 X 3/4"
20	F83451201	11	SMS, PAN X HD, #8 X 1/2"
19	F83440301	2	SMS, FLAT CROSS HEAD #10 X 1.50"
18	F82021407	4	BOLT, ELEV 1/4-20 X 1.25"
17	F03806000	2	ANGLE, SCREEN STOP, ROCKER
16	F03803501	1	BOTTOM METAL ASSY, TOP ROCKER, TOP SHOE, SX298D
15	F03803301	1	BLANK ASSY, TOP ROCKER, BTM SHOE, SX298D
14	F03801100	2	CAP, RUBBER HOLDING, ROCKER, 60.00"
13	F03801100	2	CAP, RUBBER HOLDING, ROCKER, 17.00"
12	F03800401	2	LINER WLDMT, SCREENWAY, ROCKER, 77.00"
11	F03800002	1	BRACE, BOTTOM, ROCKER, #8
10	F03601610	1	BOARD, REAR CROSS, TOP ROCKER, TOP SHOE, SX298D
9	F03601402	1	SIDE, LH, TOP ROCKER, TOP SHOE, SX29D/SX298D
8	F03601400	1	SIDE, RH, TOP ROCKER, TOP SHOE, SX29D/SX298D
7	F03505800	1	GIRT WLDMT, PIPE, ROCKER #8
6	F03500800	2	SCREEN HOOK ASSY, STANDARD
5	F03500600	2	CUP WLDMT, ROCKER, HEAVY DUTY BRUSH
4	66783300	4	NUT, HEX SERR LOCK 1/4-20
3	66782600	6	NUT, HEX SERR LOCK 10-24
2	65852226	4	SMS, FLT X HD #8 X 1.25"
1	60282626	6	BOLT, CARR 10-24 X 1.25"

CLIPPER
SEPARATION TECHNOLOGIES
SINCE 1988

DIVISION OF
A.T.FERRELL COMPANY
1440 S ADAMS ST
BLUFFTON, INDIANA
46714 - USA
PH: 260-824-3400
FAX: 260-824-5463

This drawing is the property of the A.T. Ferrell Company, Inc and must be returned immediately upon request. No part of this drawing may be reproduced, stored in a retrieval system or transmitted in any form or by any means, without prior written consent of the A.T. Ferrell Company, Inc.

TOLERANCES EXCEPT AS NOTED	TITLE: ROCKER ASSY, TOP, TOP SHOE, SX298D	
DECIMAL: XX ± .030	FRACTIONAL: ± 1/32	FINISH:
XXX ± .005	ANGULAR: ± 1/2°	NONE
XXXX ± .001		
CAD	NO MANUAL CHANGES	SCALE: 0.19:1
	SHEET: 2 OF 3	SIZE: D
	PART NUMBER: F03502110	REV: C

NOTES:
 1. DO NOT SCALE FROM DRAWING.
 2. ONE PIECE REQUIRED PER F03013304/07: SHOE ASSY, RH/LH TOP W/ ROCKERS, SX298D.

REVISION HISTORY				
REV	ECN	DESCRIPTION	DATE	APPROVED
A	XXXXXX	RELEASE	5/9/1957	DR
B	F120091	WAS C SIZE GROUP DRAWING, F03803301, -6000 & F90005100 WAS F10512601, F03803400 & F90005300	10/5/2012	dmjohnson
C	F130052	ROTATE ROCKER CUPS 30 DEG	4/5/2013	dmjohnson

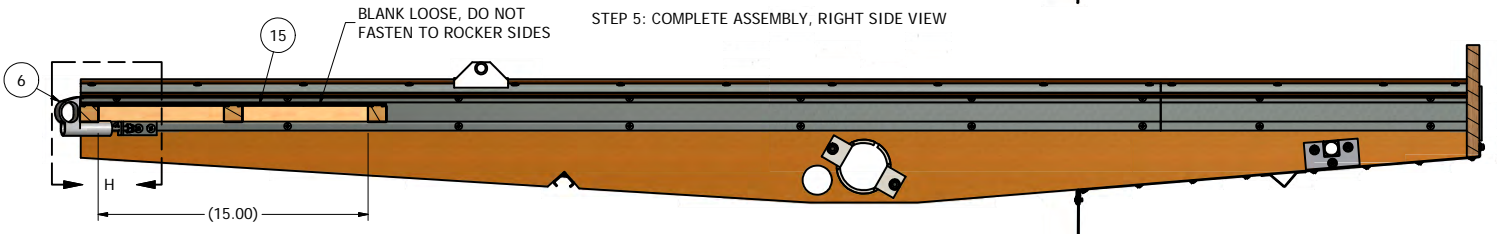
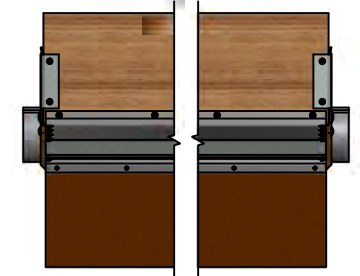
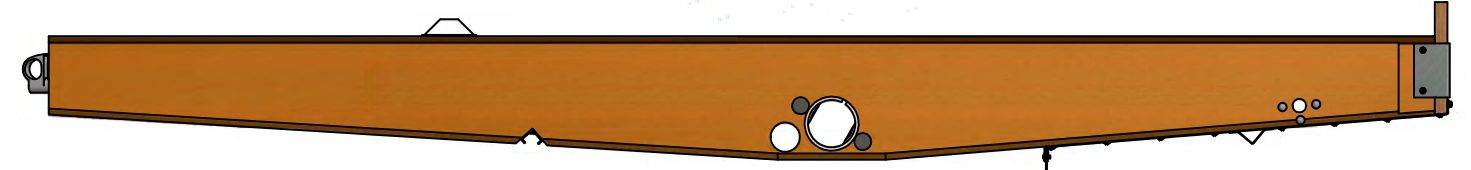
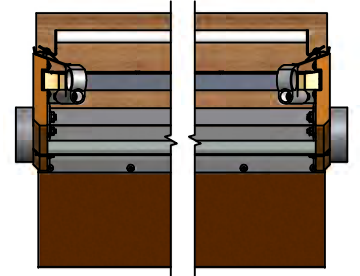
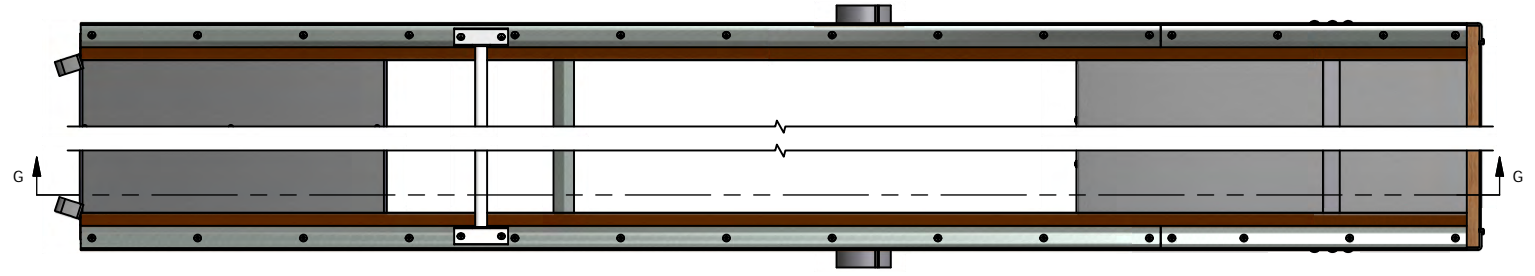

INSTALL ALL SCREEN HOOKS @ FINAL ASSEMBLY OR SHIP LOOSE FOR SHIPOUT/REPLACEMENT ROCKER

DETAIL H SCALE 1/2

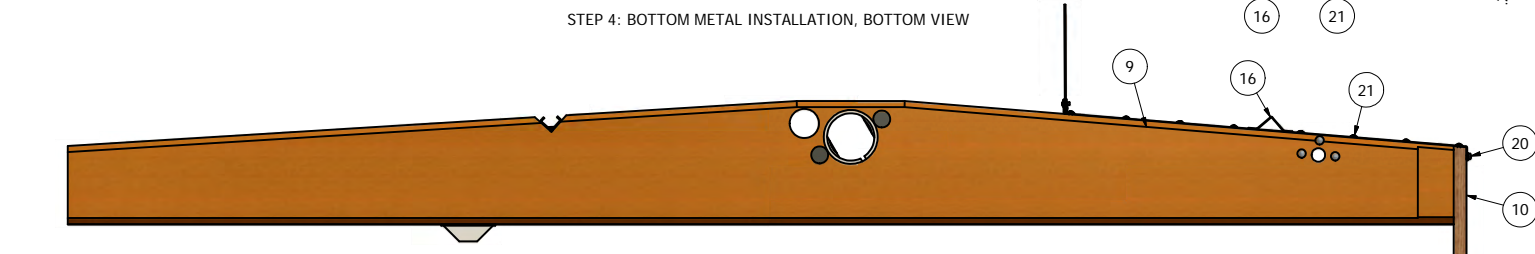
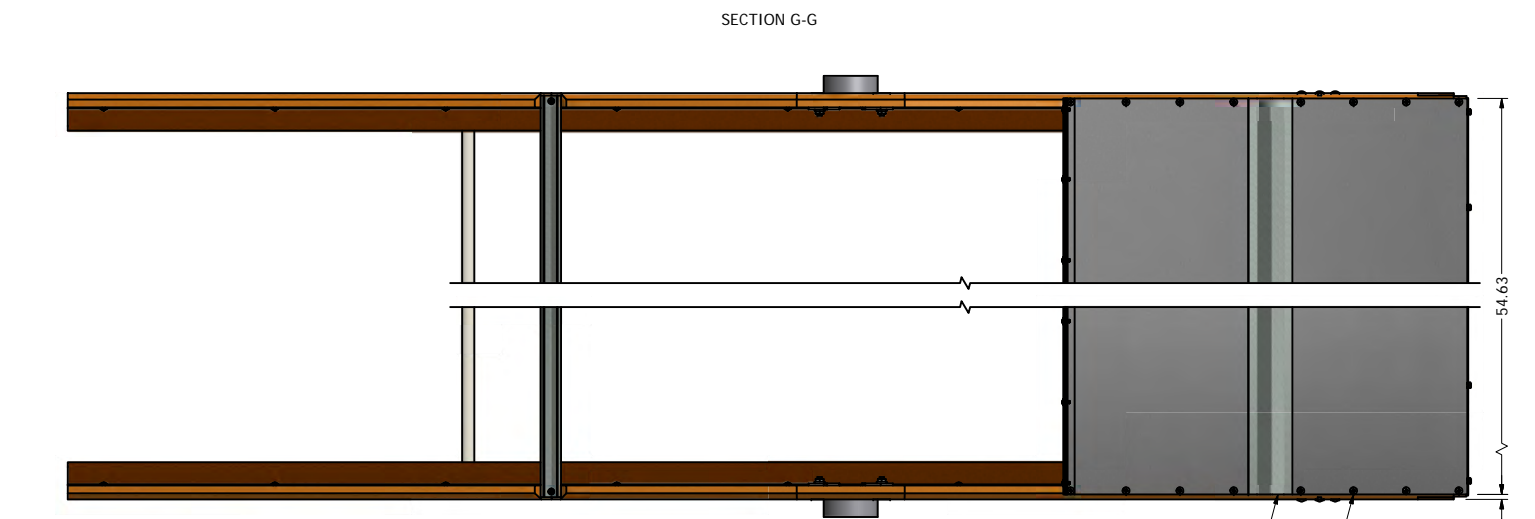

ITEM	PART NUMBER	QTY	DESCRIPTION
25	F91152006	13.167 ft	BELTING, 3 PLY FSXFS 2.50 X 79.00"
24	F90005100	1	GIRT WLDMT, ROCKER ADJUSTMENT, CENTERED, #8
23	F84212122	4	SMS, FLT X HD #8 X 3/4"
22	F83453403	4	SMS, PAN X HD, #10 X 3/4"
21	F83453402	86	SMS, PAN X HD, #8 X 3/4"
20	F83451201	11	SMS, PAN X HD, #8 X 1/2"
19	F83440301	2	SMS, FLAT CROSS HEAD #10 X 1.50"
18	F82021407	4	BOLT, ELEV 1/4-20 X 1.25"
17	F03806000	2	ANGLE, SCREEN STOP, ROCKER
16	F03803501	1	BOTTOM METAL ASSY, TOP ROCKER, TOP SHOE, SX298D
15	F03803301	1	BLANK ASSY, TOP ROCKER, BTM SHOE, SX298D
14	F03801100	2	CAP, RUBBER HOLDING, ROCKER, 60.00"
13	F03801100	2	CAP, RUBBER HOLDING, ROCKER, 17.00"
12	F03800401	2	LINER WLDMT, SCREENWAY, ROCKER, 77.00"
11	F03800002	1	BRACE, BOTTOM, ROCKER, #8
10	F03601610	1	BOARD, REAR CROSS, TOP ROCKER, TOP SHOE, SX298D
9	F03601402	1	SIDE, LH, TOP ROCKER, TOP SHOE, SX29D/SX298D
8	F03601400	1	SIDE, RH, TOP ROCKER, TOP SHOE, SX29D/SX298D
7	F03505800	1	GIRT WLDMT, PIPE, ROCKER #8
6	F03500800	2	SCREEN HOOK ASSY, STANDARD
5	F03500600	2	CUP WLDMT, ROCKER, HEAVY DUTY BRUSH
4	66783300	4	NUT, HEX SERR LOCK 1/4-20
3	66782600	6	NUT, HEX SERR LOCK 10-24
2	65852226	4	SMS, FLT X HD #8 X 1.25"
1	60282626	6	BOLT, CARR 10-24 X 1.25"

NOTES:
 1. DO NOT SCALE FROM DRAWING.
 2. ONE PIECE REQUIRED PER F03013304/07: SHOE ASSY, TOP W/ ROCKERS, SX298D.

CLIPPER
SEPARATION TECHNOLOGIES
SINCE 1988

DIVISION OF
A.T.FERRELL COMPANY
 1440 S ADAMS ST
 BLUFFTON, INDIANA
 46714 - USA
 PH: 260-824-3400
 FAX: 260-824-5463

This drawing is the property of the A.T. Ferrell Company, Inc and must be returned immediately upon request. No part of this drawing may be reproduced, stored in a retrieval system or transmitted in any form or by any means, without prior written consent of the A.T. Ferrell Company, Inc.

TOLERANCES EXCEPT AS NOTED		TITLE:	
DECIMAL: XX ± .030	FRACTIONAL: ± 1/32	ROCKER ASSY, TOP, TOP SHOE, SX298D	
XXX ± .005	ANGULAR: ± 1/2°	FINISH:	
XXXX ± .001		NONE	
CAD	NO MANUAL CHANGES	SCALE: 0.19:1	SHEET: 3 OF 3
		SIZE: D	PART NUMBER: F03502110
			REV: C