

# SERVICE MANUAL AND PARTS CATALOG FOR YOUR SUPER 67A



*Grain, Seed and Bean Cleaners*

**Notice: This manual has been recreated from an old manual and/or drawings that were not complete. Every effort has been made to identify the correct parts for this machine but A.T. Ferrell/Clipper takes no responsibility for a part that might not be correct for your machine**

1440 SOUTH ADAMS STREET BLUFFTON, INDIANA 46714 (800) 248-8318  
[www.atferrell.com](http://www.atferrell.com) Updated July 21, 2020

# SUPER 67A CLEANER PARTS

## SET UP WITH BRUSH SCREEN CLEANING

### BRUSH SCREEN CLEANING SYSTEM

ITEM NO.	PAGE NO.	PART NUMBER	QTY.	DESCRIPTION
38	7	F01004901	3	Brush Adjusters - Idler Side (Left Hand Side)
**	7	F01004902	3	Brush Adjusters - Idler Side (Right Hand Side)
43	7	F01106300	3	Idler Arm Support
43A	7	F82080060	3	Bolt for Brush Adjusters (Both Sides)
39		Not Available		Brush Adjusters - Control Side (Left Hand Side)
**	7	F01003002	3	Brush Adjusters - Control Side (Right Hand Side)
42	7	F01105400	3	Adjustments Handle with Spring, About 12" Long
42A	7	F82080060	3	Bolt for Brush Adjusters (Both Sides)
		F01104300	6	One Hole Plate with 1-5/8" Bore
		F01000200	12	Rope Sheave Assembly Complete <b>(Includes Below)</b> <b>PLEASE SEE ATTACHED PICTURE</b>
		F09500600	2	Brush Carrier Assembly 15" x 27" with Rollers <b>(Brushes not included)</b> <b>PLEASE SEE ATTACHED PICTURE 10</b>
		F09500400	1	Brush Carrier Assembly 15" x 12" with Rollers <b>(Brushes not included)</b> <b>PLEASE SEE ATTACHED PICTURE 10A</b>

## BOTTOM FAN ASSEMBLY

With 1-1/2" Shaft

ITEM NO.	PAGE NO.	PART NUMBER	QTY.	DESCRIPTION
		F01632400	1	Fan Shaft 1-1/2" X 59" <b>(Includes Keys)</b> <b>PLEASE SEE ATTACHED PICTURE 11</b>
		F06002682	1	Bottom Fan Assembly Complete <b>PLEASE SEE ATTACHED PICTURE 12</b>
		F06302010	1	Bottom Drum Iron
		F06302110	1	Discharge Chute 4"
		F06303700	1	Breast Iron

## BOTTOM FAN ASSEMBLY

With 1-3/16" Shaft

ITEM NO.	PAGE NO.	PART NUMBER	QTY.	DESCRIPTION
		F01608000	1	Fan Shaft 1-3/16" X 59" <b>(Includes Keys)</b> <b>PLEASE SEE ATTACHED PICTURE 11 WITH 1.18 INCH</b>
		F06002677		Bottom Fan Assembly Complete <b>PLEASE SEE ATTACHED PICTURE 12 WITH 1.18 INCH</b>
201	25	F06302010	1	Bottom Drum Iron
203	25	F06302110	1	Discharge Chute 4"
204	25	F06303700	1	Breast Iron

## ECCENTRIC SHAFT ASSEMBLY

ITEM NO.	PAGE NO.	PART NUMBER	QTY.	DESCRIPTION
		F01603800	1	Eccentric Shaft 1-1/2" X 58-1/2" <b>(Includes Keys)</b> <b>PLEASE SEE ATTACHED PICTURES 15 &amp; 16</b>
		F92053126	2	6714 Flange Bearing Conversion Kit <b>( Older Machines)</b>
		F92400022	1	1-1/2" Bearing Insert Only for Above
		F92441083	1	7475 Halfmoon Bearing w/Threaded Housing <b>(Newer Machine)</b>
		F01104600	2	Counterweight Ends 1-1/2" Bore
		F19805200	1	Counterweight 19-13/16"
		F19503600	2	1-1/2" Throw Eccentric Assembly Complete <b>PLEASE SEE ATTACHED 15B PICTURE</b>

## MAIN SHOE ASSEMBLY

ITEM NO.	PAGE NO.	PART NUMBER	QTY.	DESCRIPTION
		F03004703	1	<b>Shoe Complete with Rockers (Right Hand Discharge)</b>
		F08306301	1	<b>Sand Spout (Right Hand Discharge)</b>
		F08306601	1	<b>Straw Spout (Right Hand Discharge)</b>
		F03004702	1	<b>Shoe Complete with Rockers (Left Hand Discharge) PLEASE SEE ATTACHED PRINT</b>
		F03501501	2	<b>Rocker Assembly Complete, Both PLEASE SEE ATTACHED PRINT</b>
		F08306302	1	<b>Sand Spout (Left Hand Discharge)</b>
		F08306602	1	<b>Straw Spout (Left Hand Discharge)</b>

## SCALPER SHOE ASSEMBLY

ITEM NO.	PAGE NO.	PART NUMBER	QTY.	DESCRIPTION
		F03003400	1	<b>Scalper Shoe Assembly Complete PLEASE SEE ATTACHED PRINT</b>

**Note: Front of the Machine is Where the Screens are Inserted Into the Machine.  
 Discharge Spouts are Determined by Standing at the Front and Facing the Machine.  
 Right Hand Discharge Spouts Would Discharge Towards Your Right Hand.**

### MISCELLANEOUS PARTS

ITEM NO.	PAGE NO.	PART NUMBER	QTY.	DESCRIPTION
		F90006613	1	Screen Puller Weldment 52"
		F99700034	1	Wrench 1-1/4" Jam Nut
		F08501500	1	Catchall Spout Weldment
		F08604901	1	Catchall Board for above 51-1/4" x 4"
			2	<b>Belt Idler Assembly Complete 5-1/2"(Includes Below)          PLEASE SEE ATTACHED PICTURE</b>

### PULLEYS & BELTS

ITEM NO.	PAGE NO.	PART NUMBER	QTY.	DESCRIPTION
		F91922154	1	2B15.4 SK Eccentric shaft Sheave (Is Driven By Top Fan Shaft)
		44010918	1	SK Bushing for above
		F91162144	2	B-144 Belt (From Eccentric shaft to Top Fan)
		43120079	1	2B3.6 SH Motor drive shaft Sheave (Drives Eccentric shaft)
		44010304	1	Bushing SH 5/8" for above
		43110079	1	1B3.6 SH sheave (eccentric shaft)
		44010318	1	SH bushing for above
		F04201700	1	Hopper drive sheave Right Hand, 3/4" bore

F04201800	1	Hopper drive sheave Left Hand, 3/4" bore
????	1	B ??? v-belt (from eccentric shaft to hopper)
43110079	1	1B3.6 SH sheave (eccentric shaft)
44010318	1	SH bushing for above
F11502001	1	Brush drive sheave 1" bore
????	1	B ??? v-belt (from eccentric shaft to brush drive)

**The Following Are the Ball Tray Kit Parts That were Installed on the Super 67A Cleaners in the Past**

Old Style Ball Trays with 1" Square Turkey Wire That Came Out With the Screens. Ball Trays were not attached to the Screens.

F90005067	2	Ball Tray Weldment for 1 Piece Screens
F90005065	1	Ball Tray Weldment for Scalper Screen
F80026102	180	White 1-3/8" Balls
F11301707	2	Ball Tray Support Rail 24"
F11301716	4	Ball Tray Support Rail 14"
F11301717	4	Ball Tray Support Rail 22"

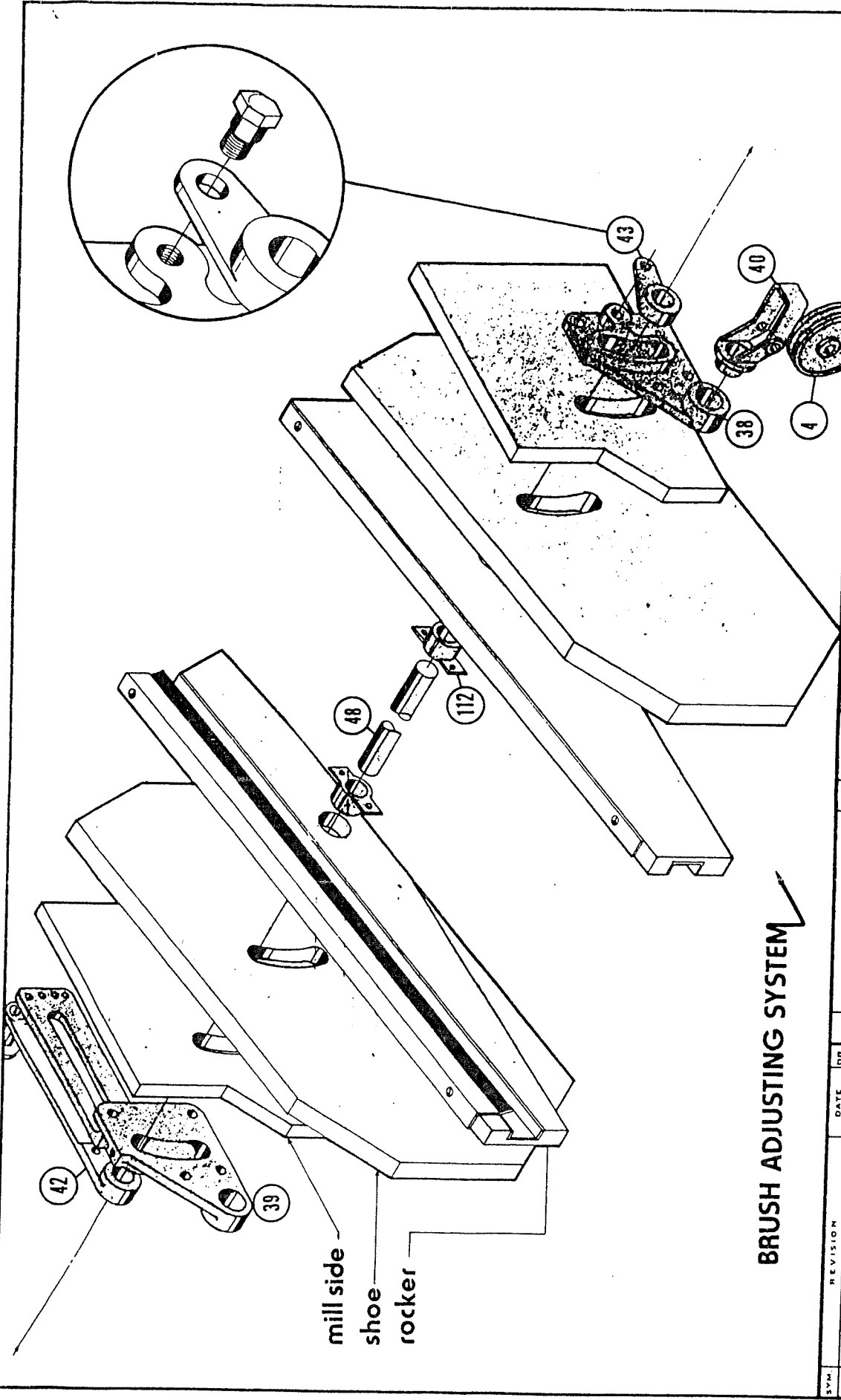

FERRELL - ROSS  
SAGINAW, MICH.

brush adjusting system

DWG. NO.

DWN. BY

SCALE

DATE

REV.	DATE	BY



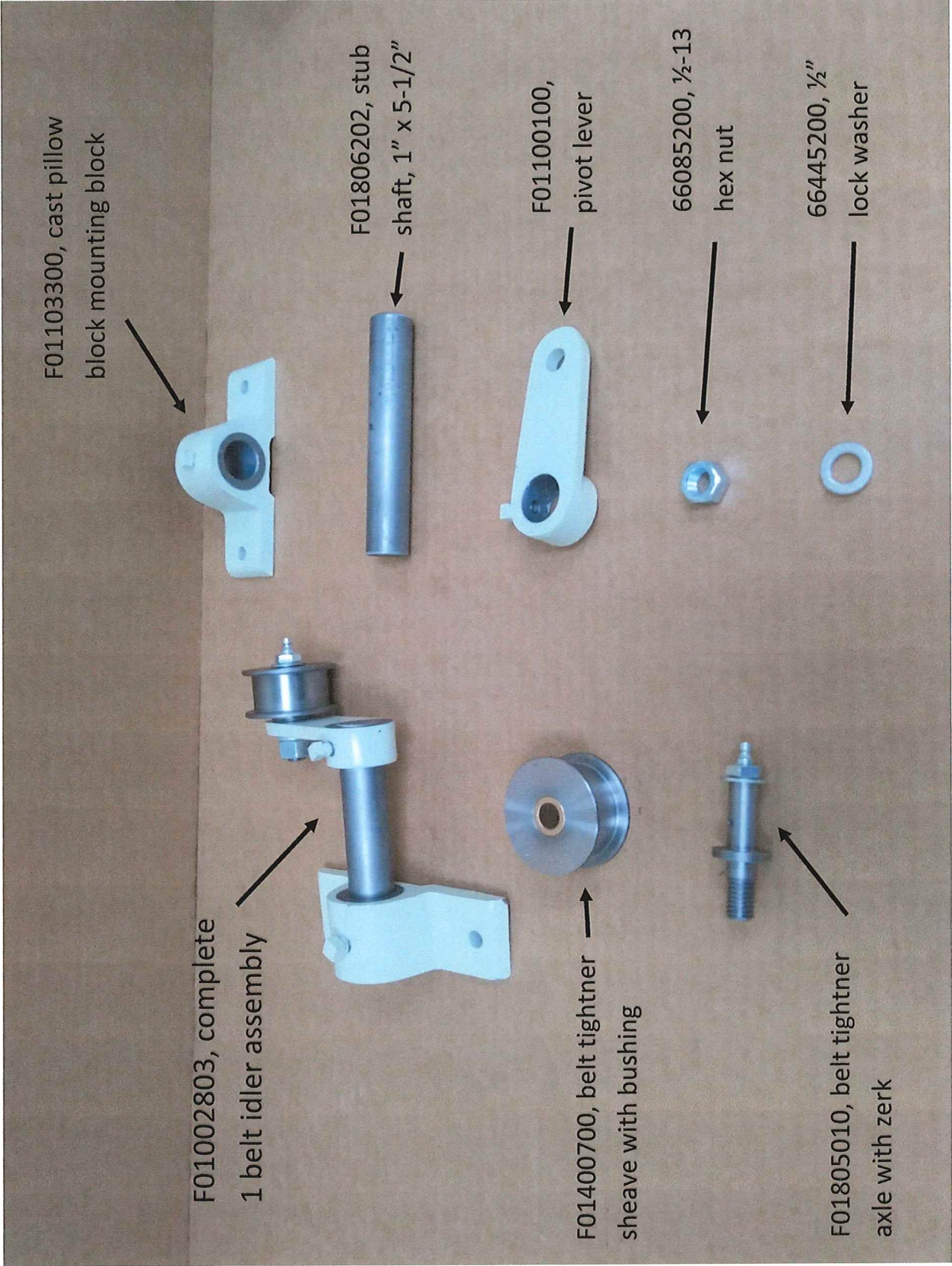

# Belt tightner assembly

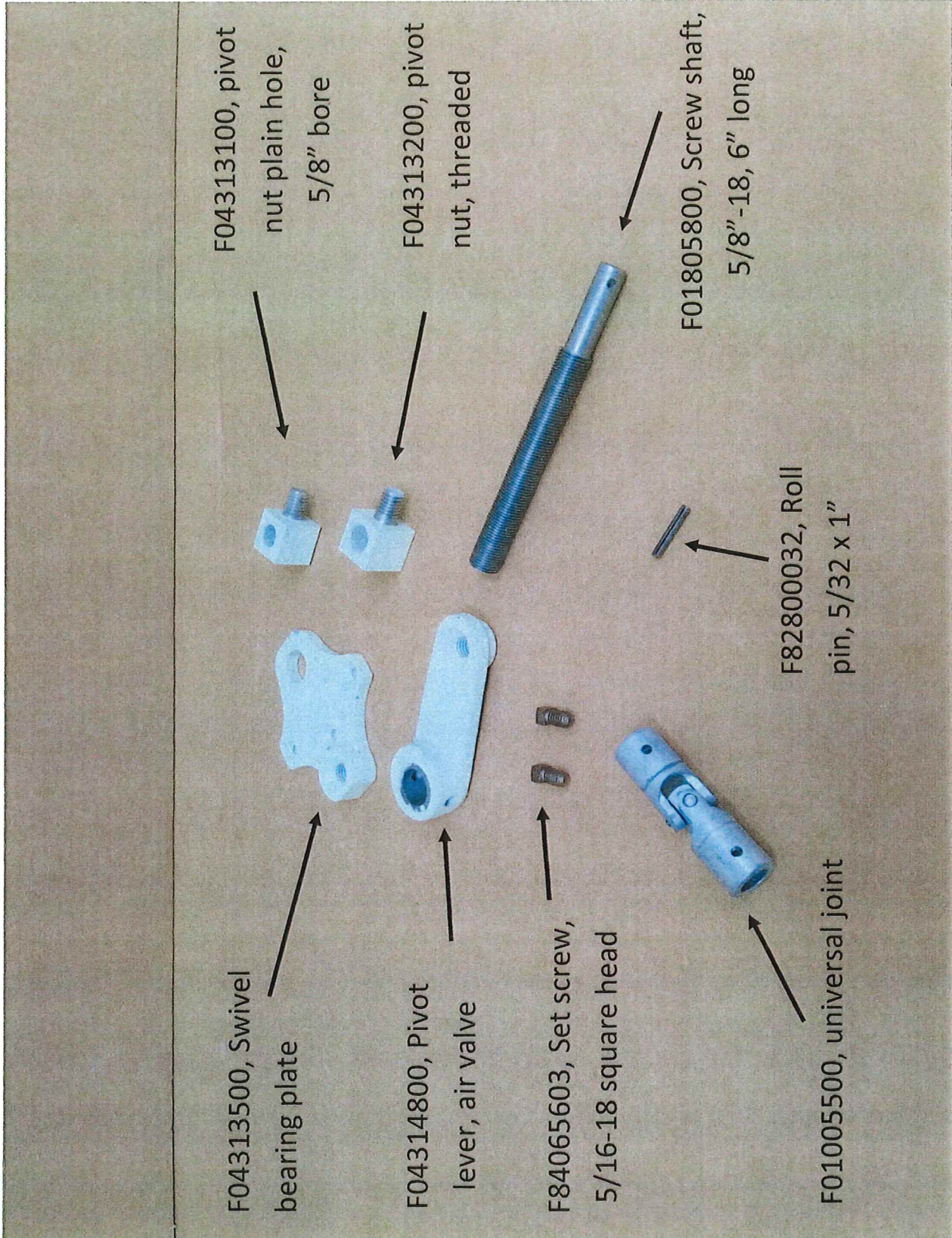

F04313100, pivot  
nut plain hole,  
5/8" bore

F04313200, pivot  
nut, threaded

F01805800, Screw shaft,  
5/8"-18, 6" long

F82800032, Roll  
pin, 5/32 x 1"

F04313500, Swivel  
bearing plate

F04314800, Pivot  
lever, air valve

F84065603, Set screw,  
5/16-18 square head

F01005500, universal joint

# F01013500, Gate valve adjusting assembly, ALL

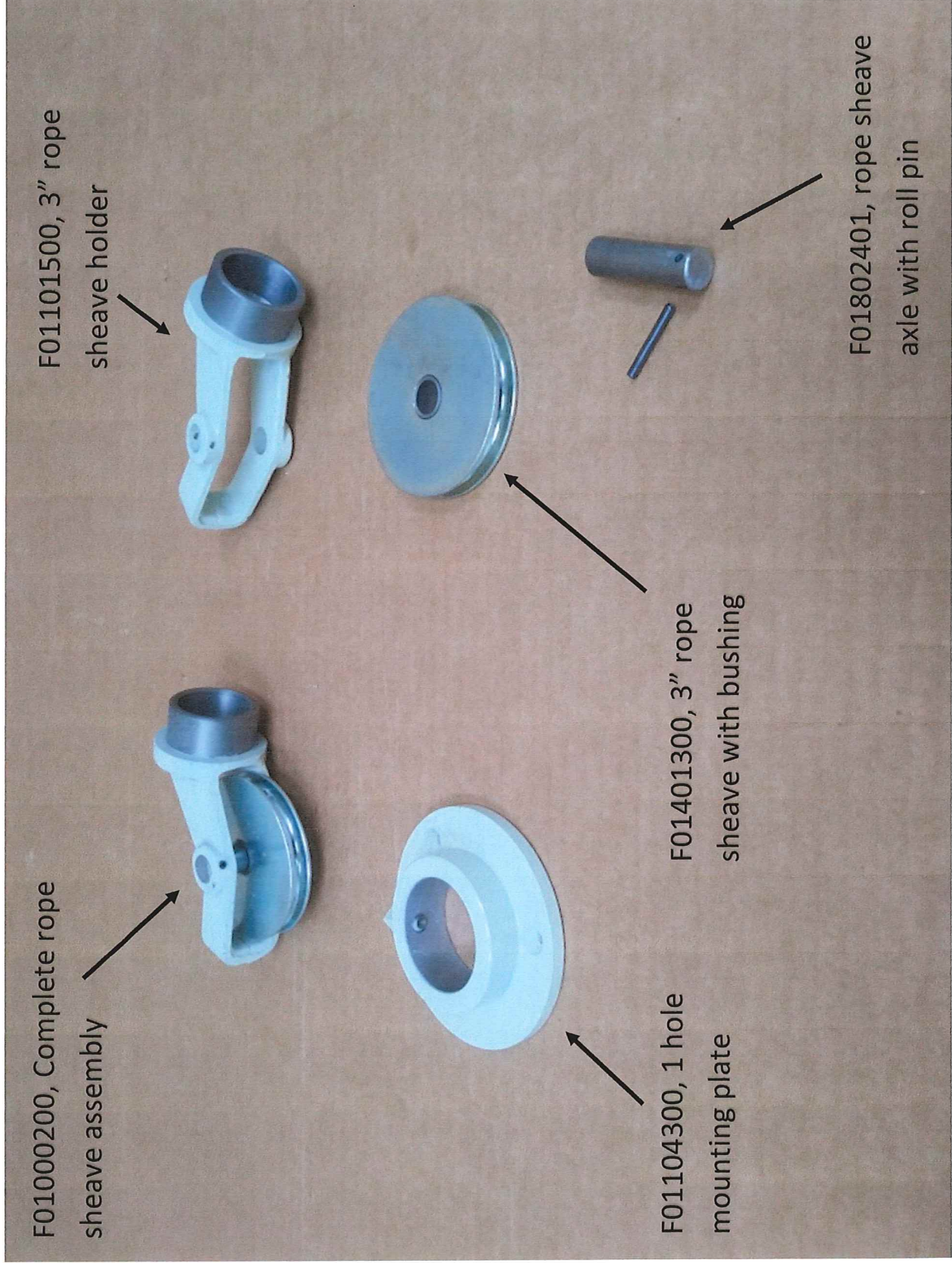

### 3" Rope sheave assembly

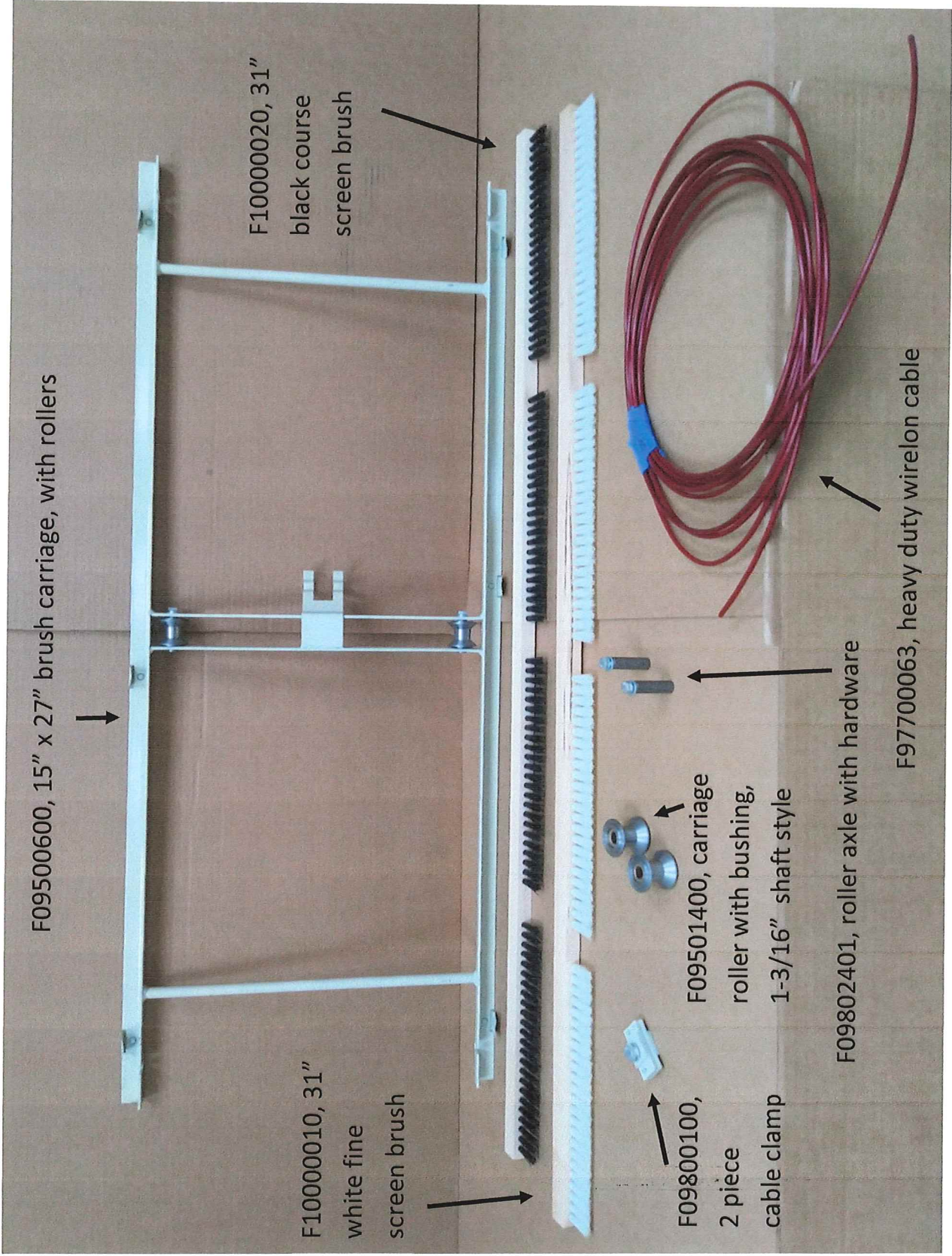

Brush carriage, with accessories, page 10

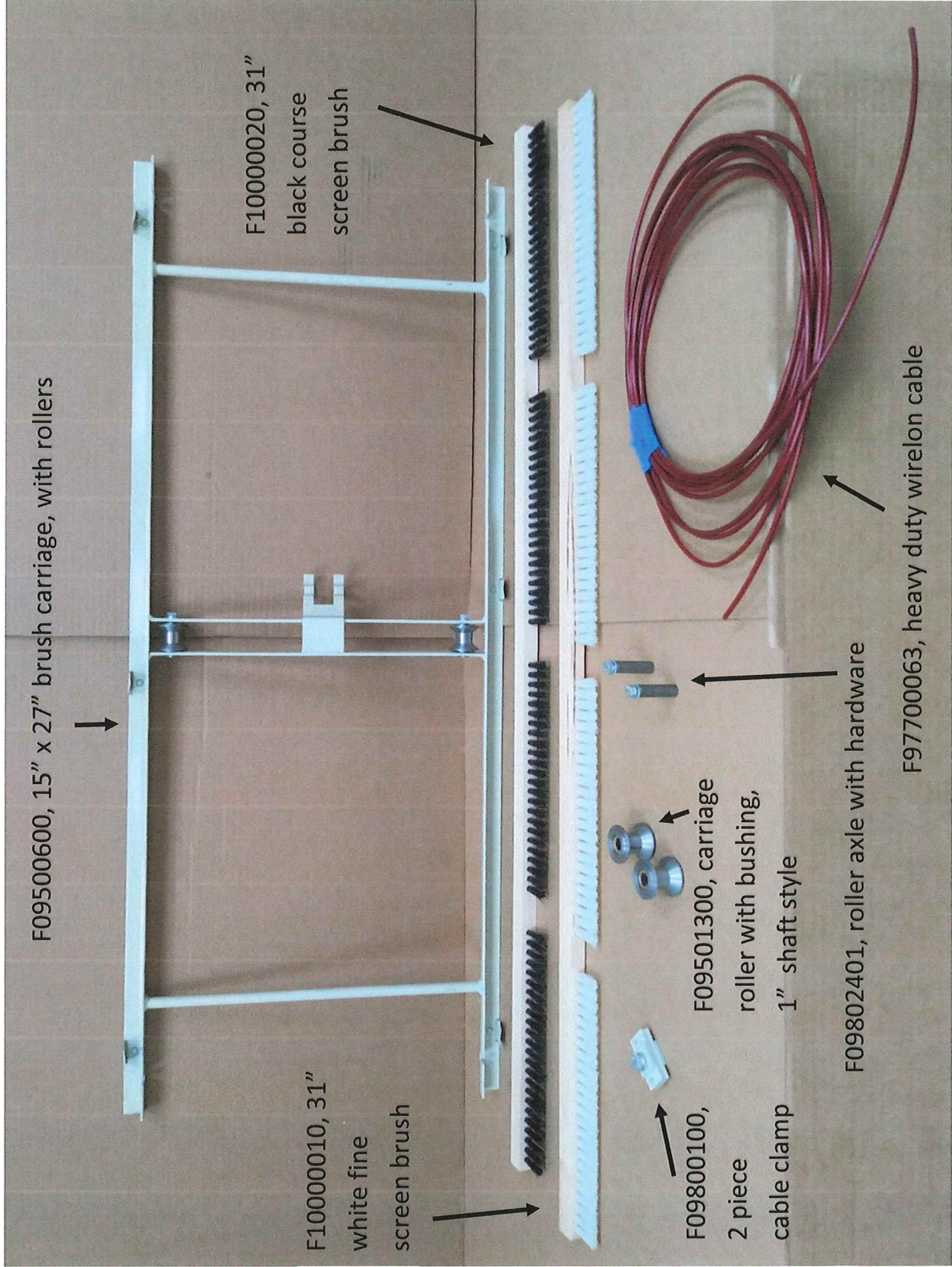

F09500600, 15" x 27" brush carriage, with rollers

F10000020, 31" black course screen brush

F10000010, 31" white fine screen brush

F09800100, 2 piece cable clamp

F09501300, carriage roller with bushing, 1" shaft style

F09802401, roller axle with hardware

F97700063, heavy duty wirelon cable

# Brush carriage, with accessories, 1" shaft page 10

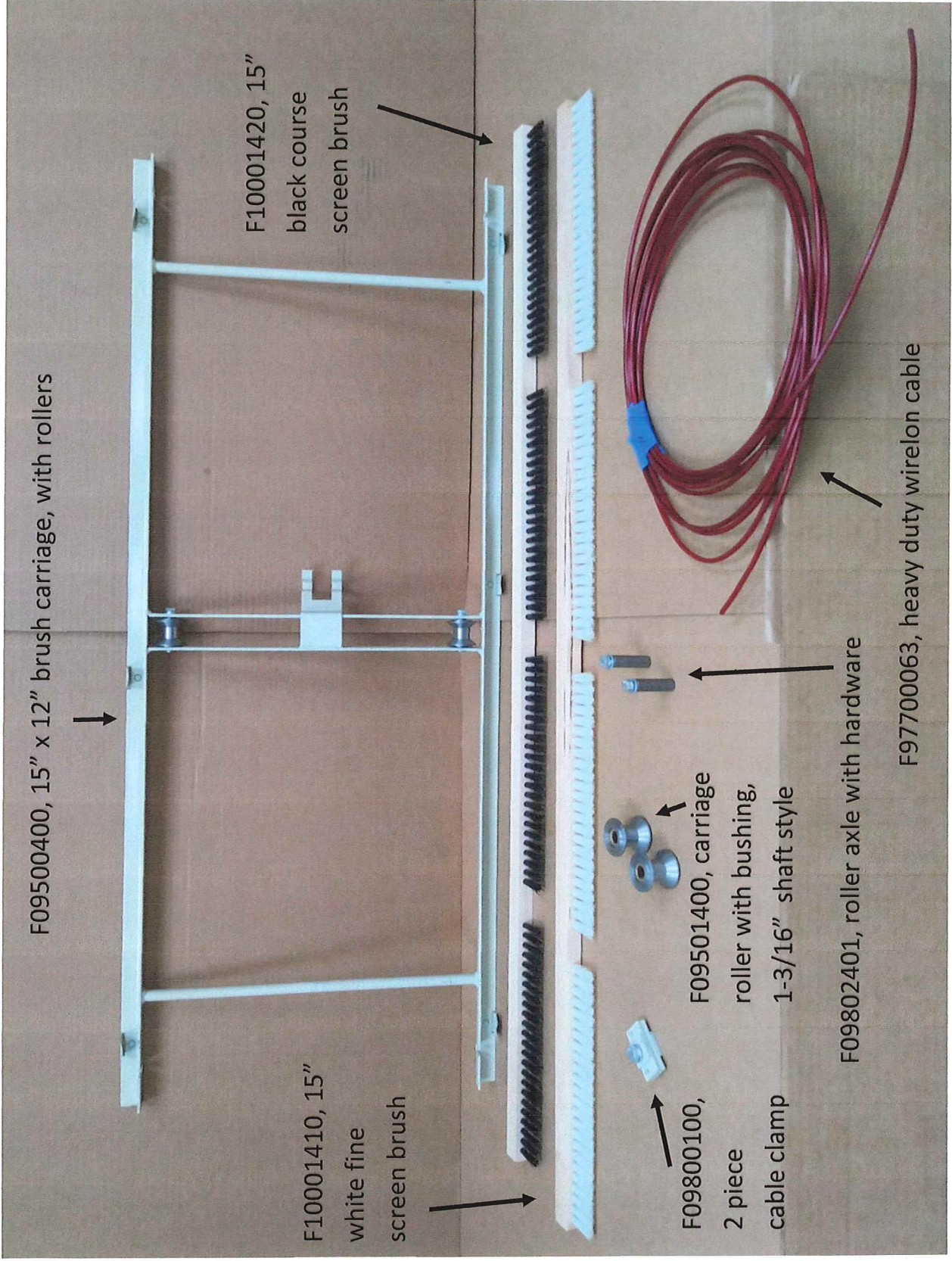

# Brush carriage, with accessories, page 10A

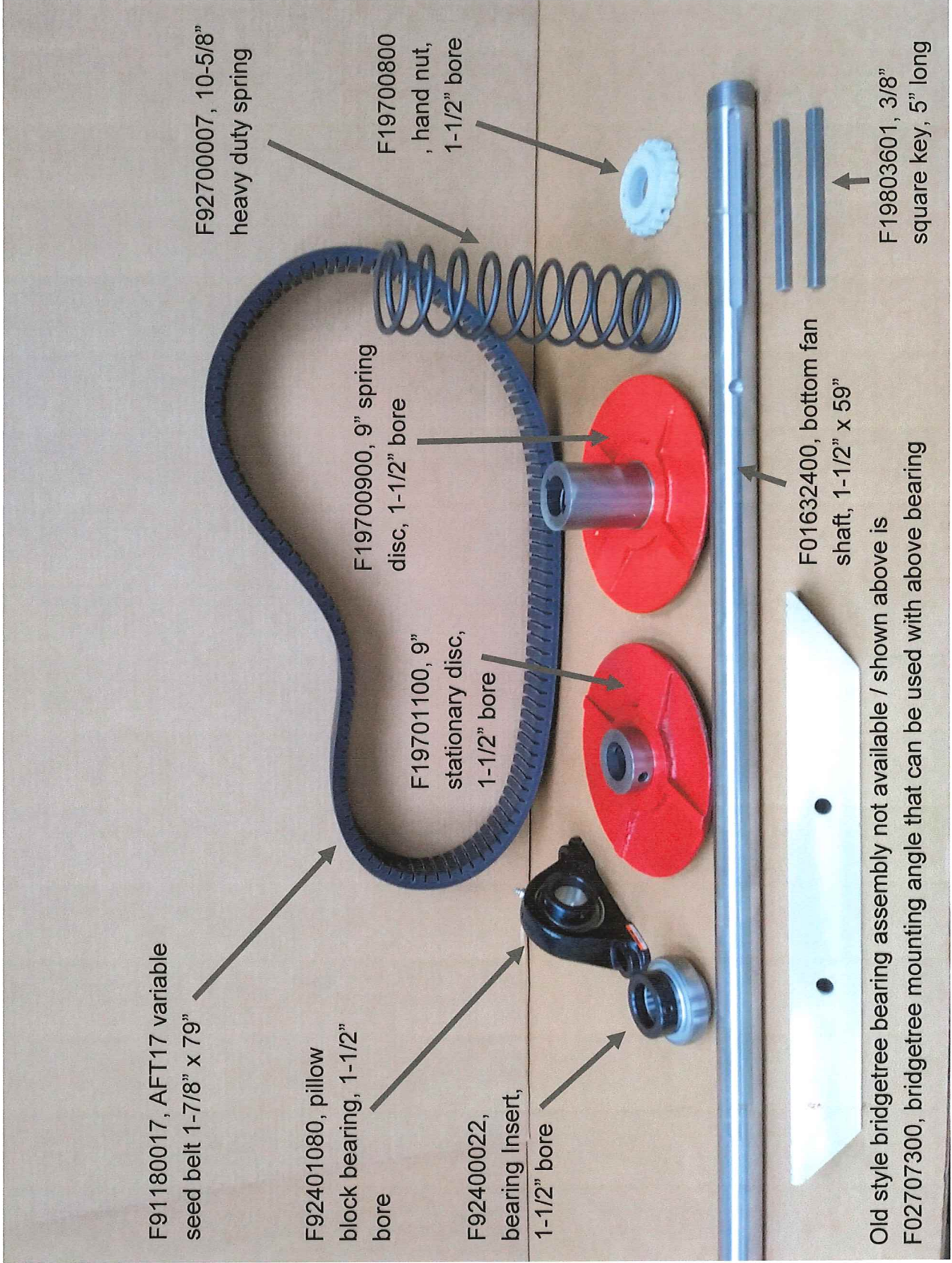

F91180017, AFT17 variable seed belt 1-7/8" x 79"

F92700007, 10-5/8" heavy duty spring

F92401080, pillow block bearing, 1-1/2" bore

F19700900, 9" spring disc, 1-1/2" bore

F19700800, hand nut, 1-1/2" bore

F19701100, 9" stationary disc, 1-1/2" bore

F92400022, bearing Insert, 1-1/2" bore

F01632400, bottom fan shaft, 1-1/2" x 59"

F19803601, 3/8" square key, 5" long

Old style bridgetree bearing assembly not available / shown above is F02707300, bridgetree mounting angle that can be used with above bearing

## Bottom fan shaft assembly assembly, page 11

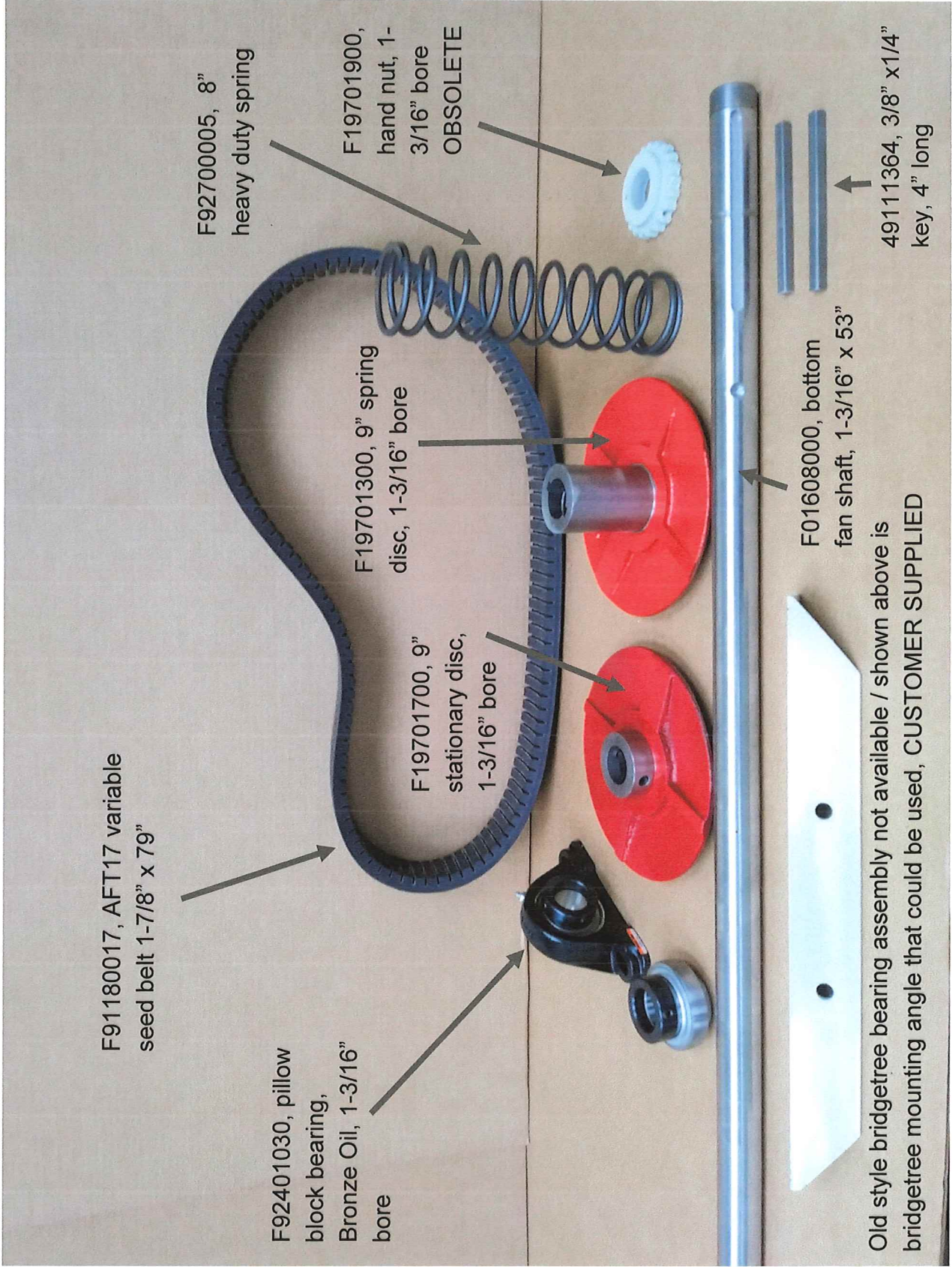

F91180017, AFT17 variable  
seed belt 1-7/8" x 79"

F92700005, 8"  
heavy duty spring

F92401030, pillow  
block bearing,  
Bronze Oil, 1-3/16"  
bore

F19701900,  
hand nut, 1-  
3/16" bore  
OBSOLETE

F19701300, 9" spring  
disc, 1-3/16" bore

F19701700, 9"  
stationary disc,  
1-3/16" bore

F01608000, bottom  
fan shaft, 1-3/16" x 53"

Old style bridgetree bearing assembly not available / shown above is  
bridgetree mounting angle that could be used, CUSTOMER SUPPLIED

49111364, 3/8" x 1/4"  
key, 4" long

**Bottom fan shaft assembly assembly, 1-3/16" shaft, page 11**



2 pieces, F06001000, bottom fan spider, 1-1/2" bore

F06002682, complete bottom fan assembly

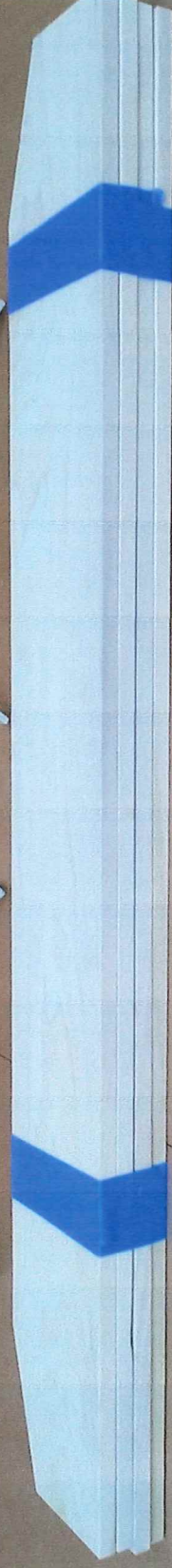
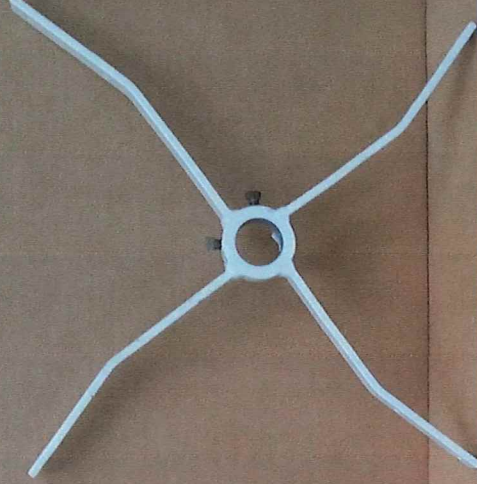
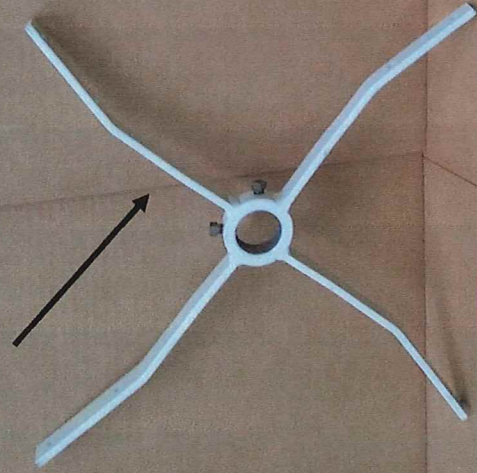

4 pieces, F01701104, bottom fan blade, 35-5/8" long

16 pieces, F82021407, elevator bolt, 1/4-20 x 1-1/4"

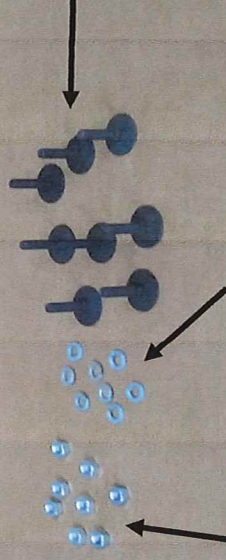

16 pieces, 66443300, 1/4" lock nut

16 pieces, 66083300, 1/4-20 hex nut

Bottom fan assembly, 1-1/2" shaft, 7 wide, page 12

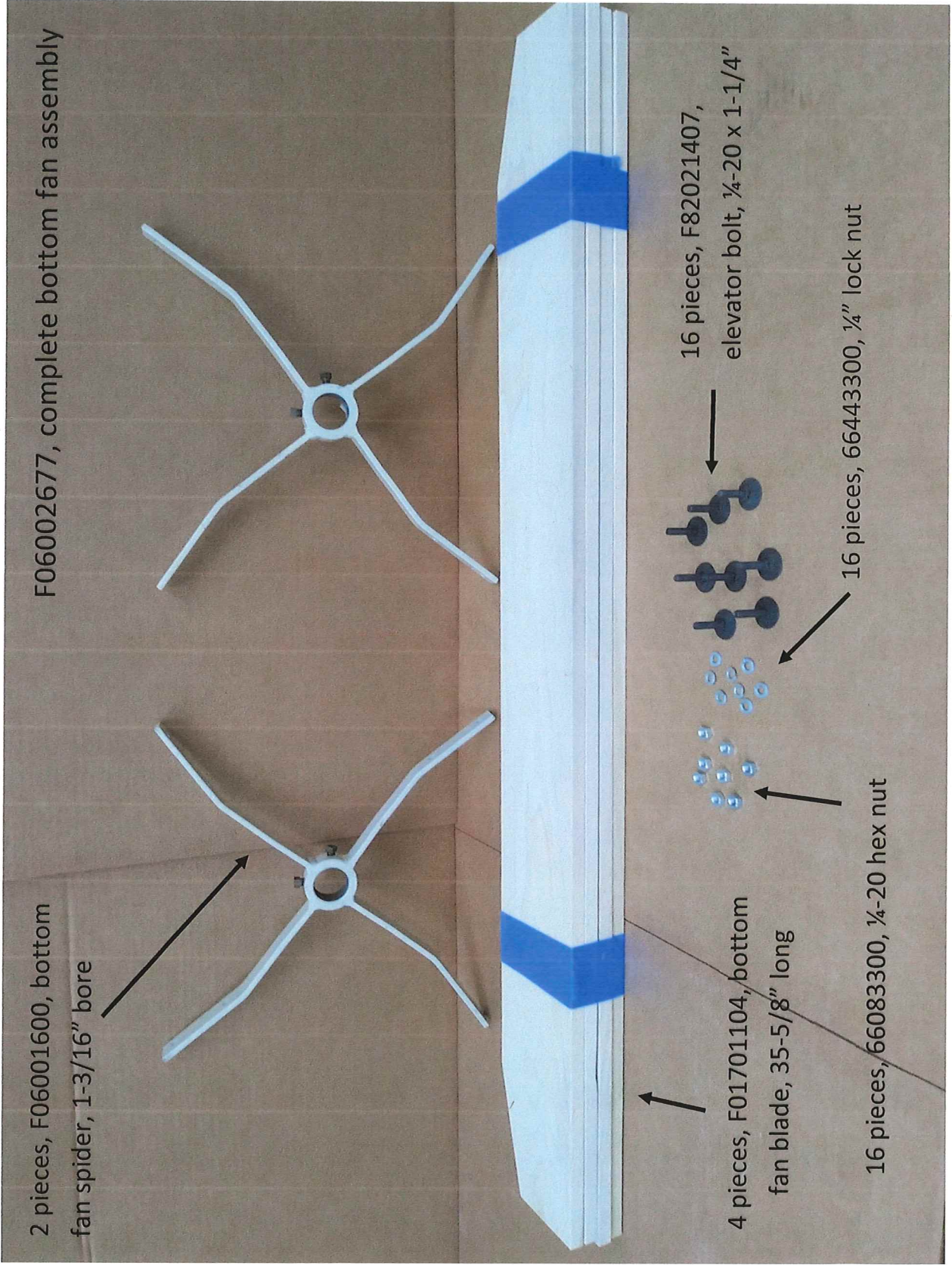

Bottom fan assembly, 1-3/16" shaft, 7 wide, page 12

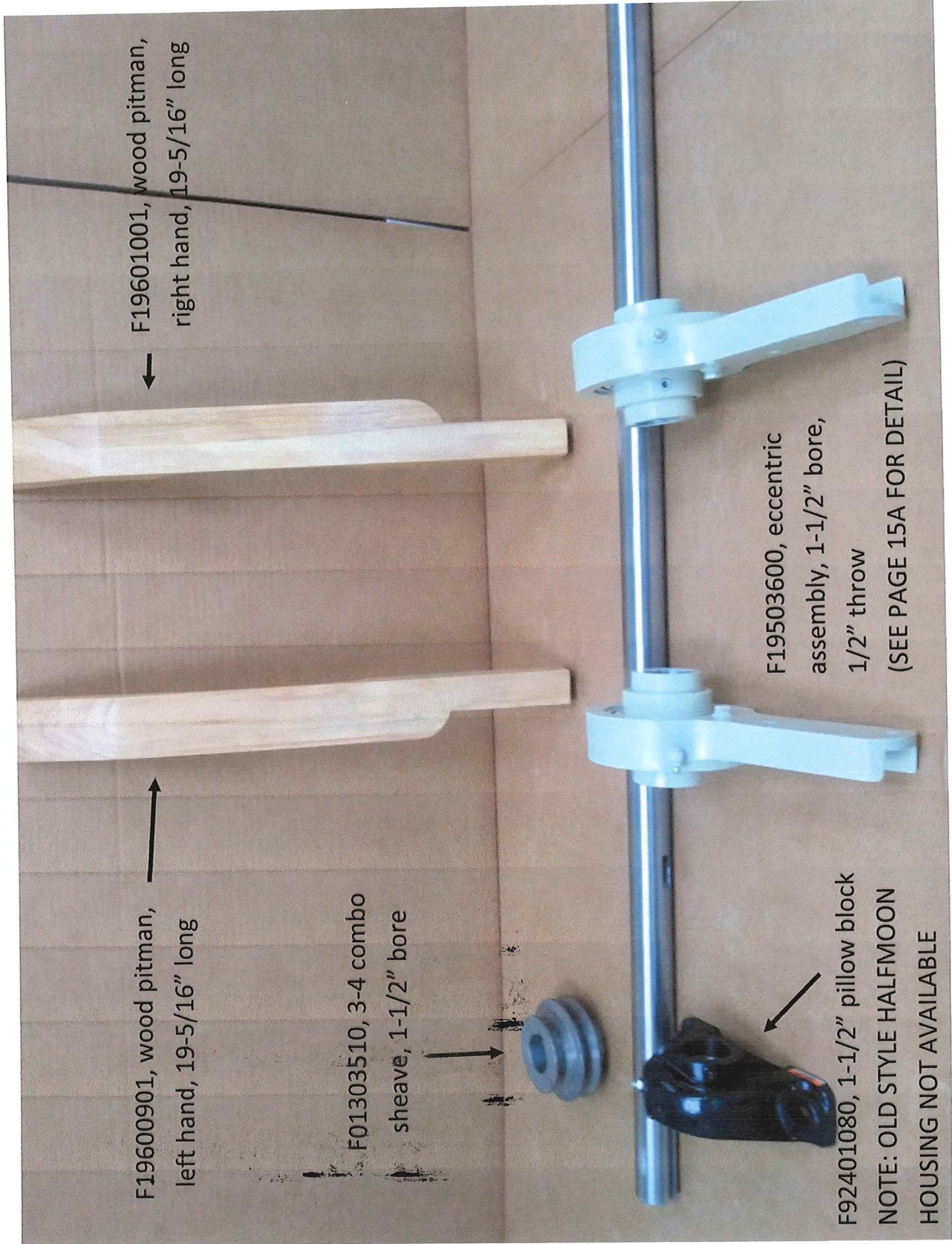

F19600901, wood pitman,  
left hand, 19-5/16" long

F19601001, wood pitman,  
right hand, 19-5/16" long

F01303510, 3-4 combo  
sheave, 1-1/2" bore

F19503600, eccentric  
assembly, 1-1/2" bore,  
1/2" throw  
(SEE PAGE 15A FOR DETAIL)

F92401080, 1-1/2" pillow block  
NOTE: OLD STYLE HALFMOON  
HOUSING NOT AVAILABLE

# Eccentric shaft, wood pitmans, page 15

F19503600, Complete eccentric assembly, 1-1/2" bore, 1/2" throw



F19703000, Eccentric housing



F92400053, Bearing insert



F19804004, Eccentric hub, 1-1/2" bore, 1/2" throw



F19503602, Complete eccentric assembly, 1-3/16" bore, 1/8" throw



F19703000, Eccentric housing

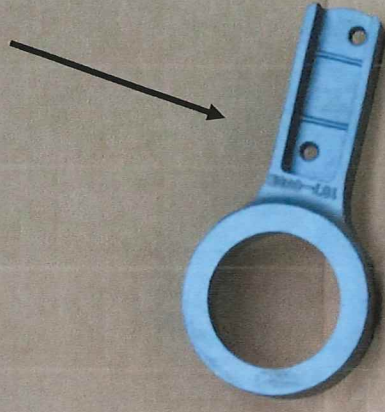

F92400053, Bearing insert



F19804008, Eccentric hub, 1-3/16" bore, 1/8" throw



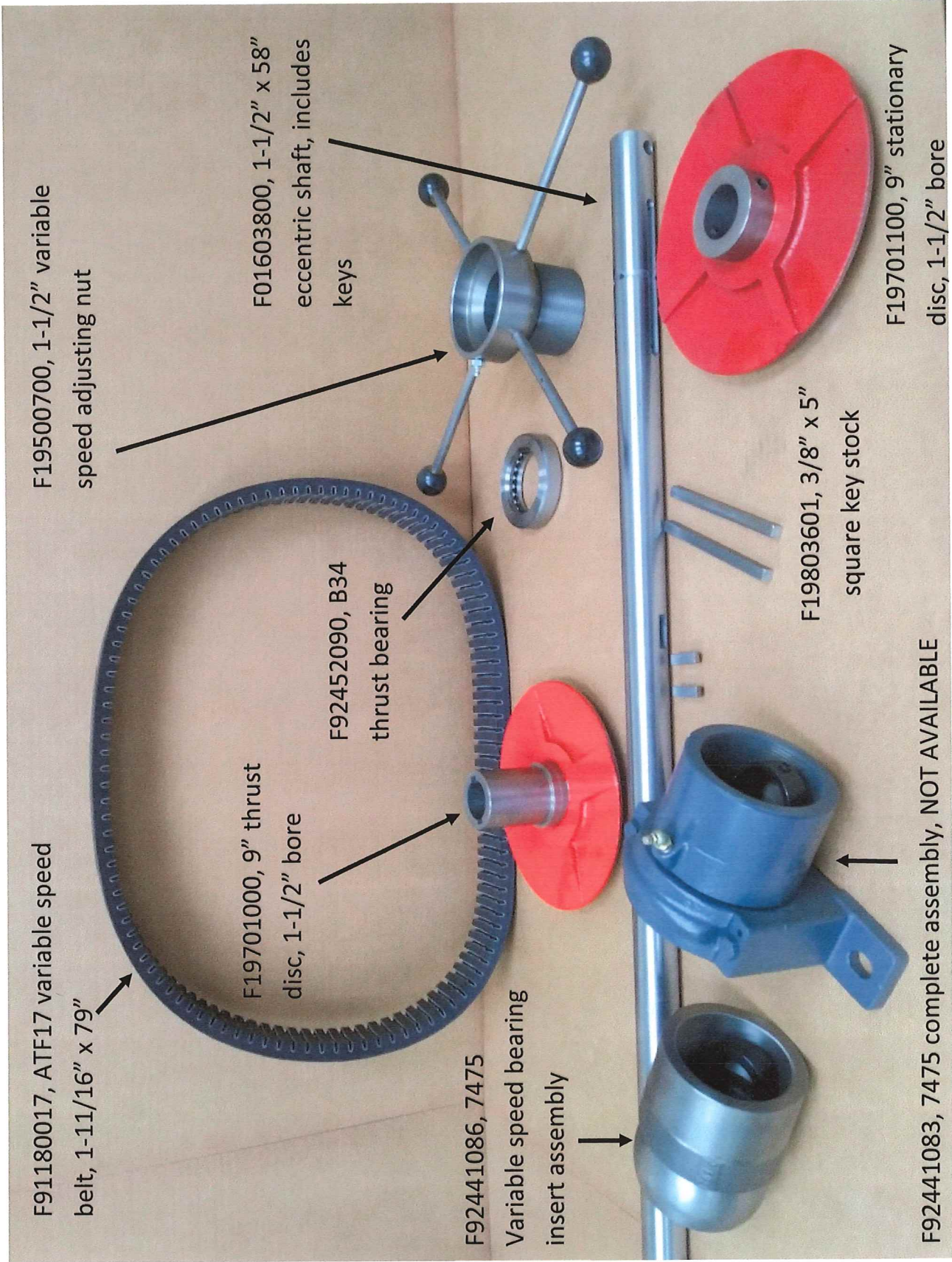

F91180017, ATF17 variable speed belt, 1-11/16" x 79"

F19500700, 1-1/2" variable speed adjusting nut

F19701000, 9" thrust disc, 1-1/2" bore

F92452090, B34 thrust bearing

F01603800, 1-1/2" x 58" eccentric shaft, includes keys

F92441086, 7475 Variable speed bearing insert assembly

F19803601, 3/8" x 5" square key stock

F19701100, 9" stationary disc, 1-1/2" bore

F92441083, 7475 complete assembly, NOT AVAILABLE

# Eccentric shaft assembly, Super 47,67 page 16

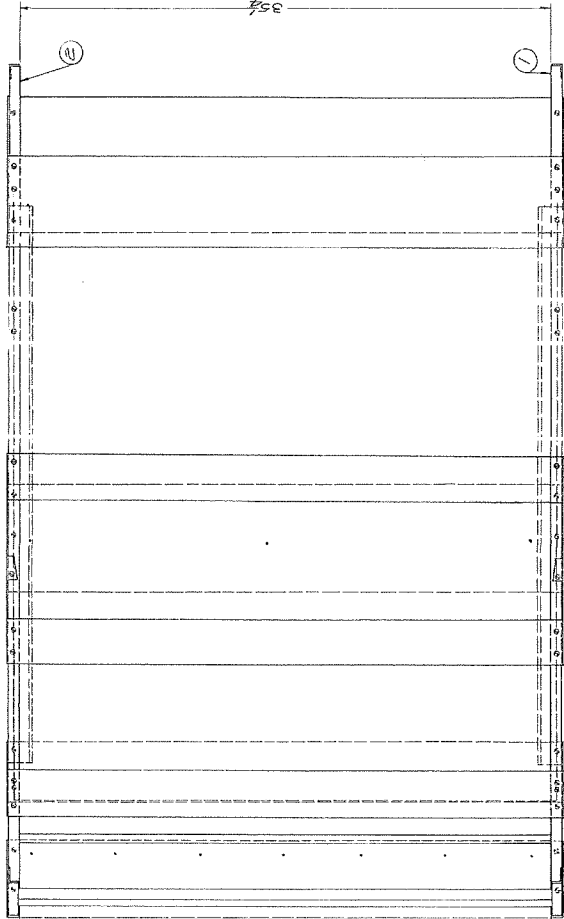

NOTE:  
FOR SHOES WITH ROCKERS INCLUDED USE:  
L.H. # 30-0472B  
R.H. # 30-0473B

L.H. ASSEMBLY SHOWN #30-0476C.  
R.H. ASSEMBLY OPPOSITE #30-0476C.

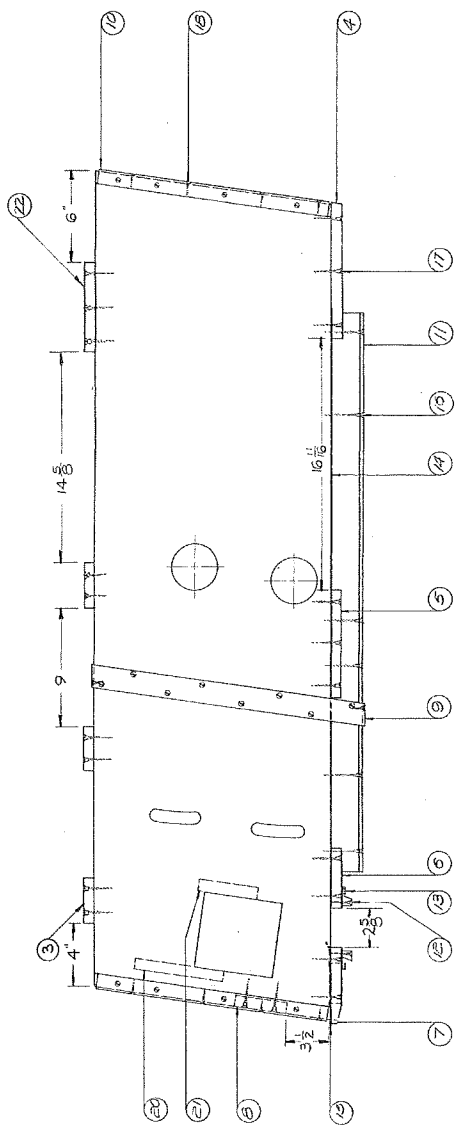

19 FLATZIN METAL BOTTOM TO SHOE  
SIDE WITH 1/4" GA. TANK - 50 CERRA

ITEM	PART NO	QTY	NAME	MATERIAL
22	F03117403	1	BOARD 6"	MAPLE
21	31-101	1	CURT-SPROUT	MAPLE
20	31-102	1	CURT-SPROUT	MAPLE
19	F22000072	74	NAIL	STD #14 GA
18	F8040076	25	SCREEN-WOOD	STL #10-VELT AD
17	F2440101	25	SCREEN-WOOD	STL #10-VELT AD
16	31-103	1	SPRINT-NORM	STL #10-VELT AD
15	31-093	1	STRIP-NORM	STL #10-VELT AD
14	31-094	1	SLIDE-SPROUT	STL #10-VELT AD
13	31-091	2	TRACK-SPROUT	MAPLE
12	31-094	2	TRACK-SPROUT	MAPLE
11	31-093	2	RUNNER	OAK
10	31-093	2	IRON-END	STL
9	31-095	2	BRACE-SIDE	STL
8	31-099	1	BOARD-BACK END	MAPLE
7	31-095	1	BOARD-BACK	BEHLWAL
6	31-097	1	BOARD-BOTTOM	MAPLE
5	31-095	1	BOARD-FITTING	MAPLE
4	31-095	1	BOARD-FRONT	MAPLE
3	31-100	3	BOARD-TOP	MAPLE
2	31-092	1	SIDE-SHOE	OAK L.H.
1	31-091	1	SIDE-SHOE	OAK R.H.

MICROFILMED  
DATE

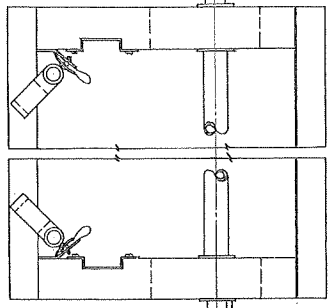
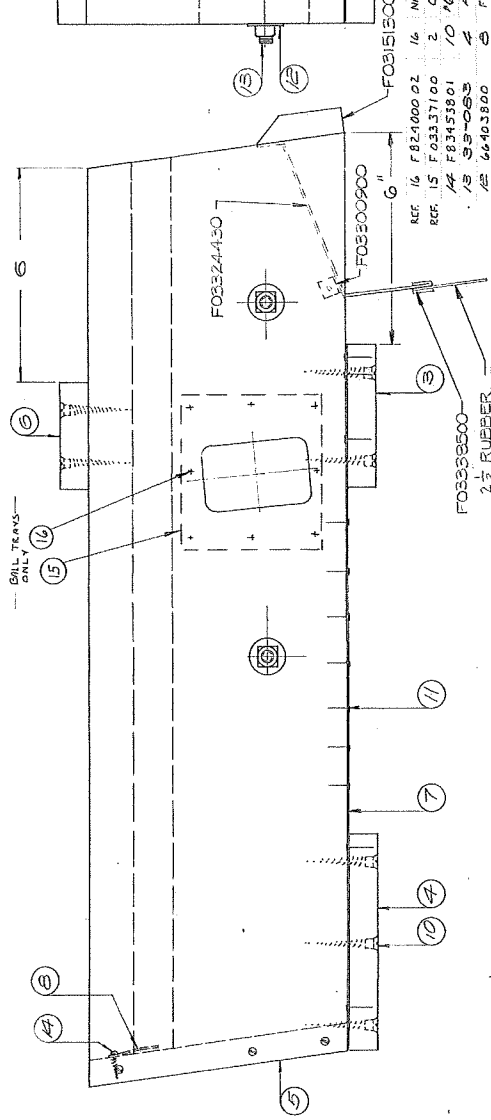
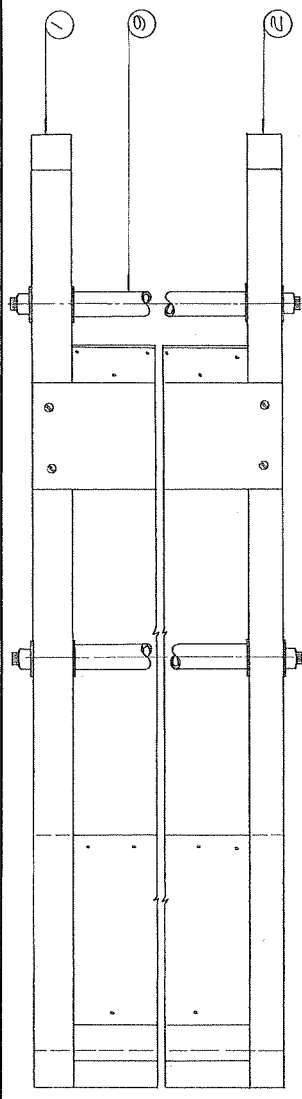

REF	16	F824000 02	16	NAIL - 3/4" - 14 GA. CHRISTENED
REF	15	F03337100	2	COVER PLATE
REF	14	F8343801	10	7/8 X 3/8 PAN HD. SH. SCL. STD
	13	98-083	4	ROD - TIE
	12	66403800	8	FLY WASHERS - 3/16 STD 3/16 ID.
	11	F824000 02	60	NAIL
	10	F83440303	20	1/8 X 2" FLT HD. W. SCREWS STD 3/8" STL.
	9	98-08300	2	BUMPER-BRUSH 3/4" 3.5 GA.
	8	98-08100	1	STOP-FILED 3/4" 3.5 GA.
	7	98-08000	1	METAL-BOTTOM 3/4" 3.5 GA.
	6	97-08700	1	BOARD-TOP 3/4" 3.5 GA.
	5	97-08500	1	BOARD-END 3/4" 3.5 GA.
	4	97-08400	1	BOARD-BOTTOM 3/4" 3.5 GA.
	3	30-033 00	1	SIDE SHADE
	2	30-032 00	1	SIDE SHADE
	1	30-032 00	1	SIDE SHADE

ITEM PART NO. QTY. PART NAME MATL. REMARKS

**MICROFILMED**  
DATE SEP 28 1984

ASSEMBLY  
SCALP  
DOWN BY: TTD BY: CSD BY:  
DATE 7-27-75 SCALE 3/4"=1'-0"  
A. T. FERRELL & CO. 274 N. W. 10th St.  
ANN ARBOR, MICH. 48106-1412

SHEET NO. CF03003400  
F03003400



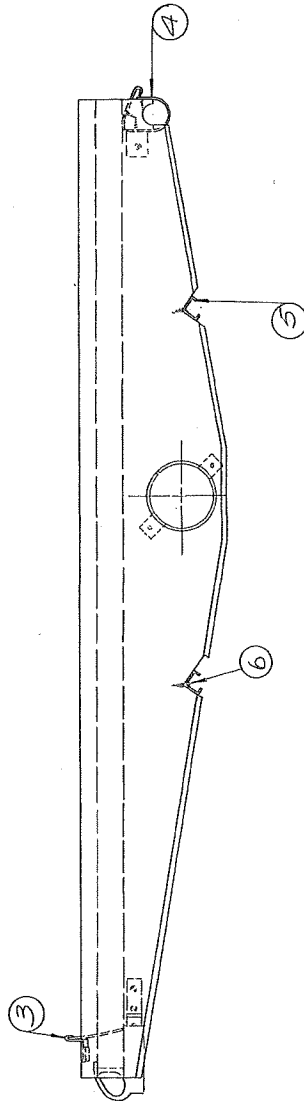
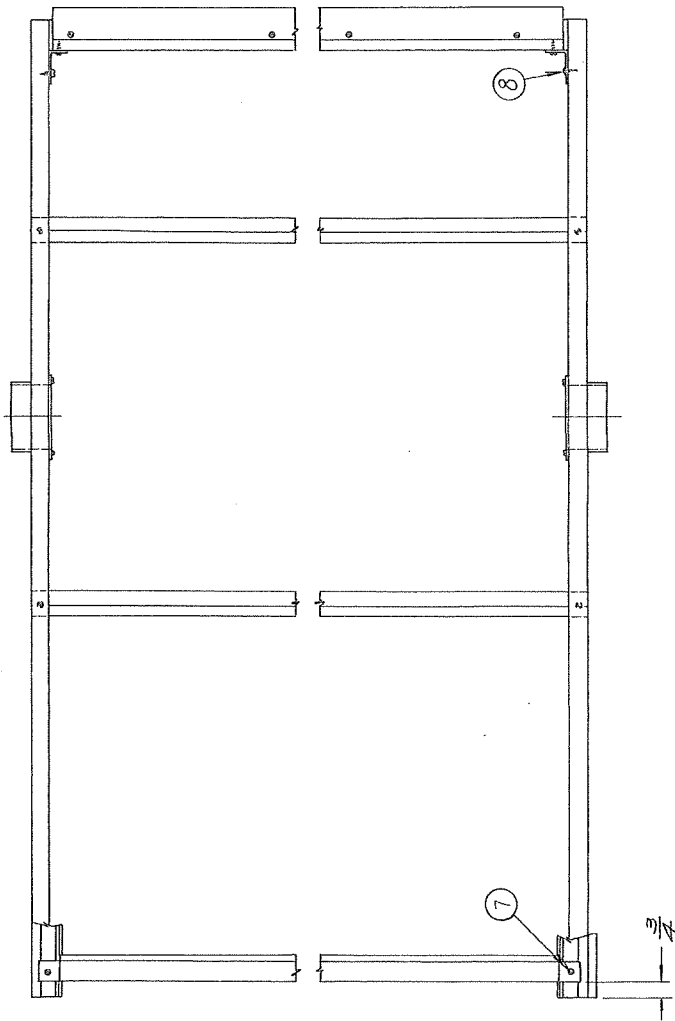

2 REQ'D

- 8 F83453402 2 #8 X 3/4 PAN HD S.M. SCR. STD
- 7 F83453402 2 SCREW STD #10 X 7/8 FLT. HD.
- 6 F84040018 4 SCREW-WOOD STD #10 X 7/8 FLT. HD.
- 5 35-000-3 2 BRACE-BOTTOM 3/4 20 GA.
- 4 35-014 1 GIRT-ROCKER AD
- 3 35-10007 1 GRAM STOP
- 2 35-016 1 ARM-ROCKER ASSY L.H.
- 1 35-016 1 ARM-ROCKER ASSY RH.

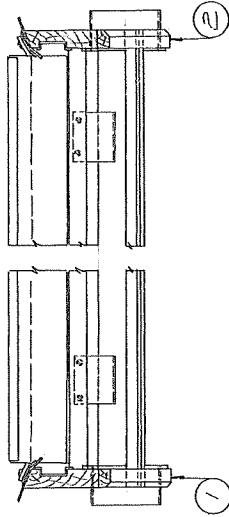

ITEM PART NO. QUAN. PART NAME. MATL. REMARKS

ASSEMBLY

**MICROFILMED**

DATE SEP 22 1961

DOWN BY: J.R. TRD. BY: CRD. BY:

DATE: 12-3-57 SCALE: 5/8

ASSY. NO. C-FD3501500

ITEM #3 USE ALL NOS

STD. FOR BALL TRAYS OMIT #4 & 8

A. T. FERRELL & CO. 574 N. W. BAGINAW, MICH. 48724

SHEET NO. C-FD3501500

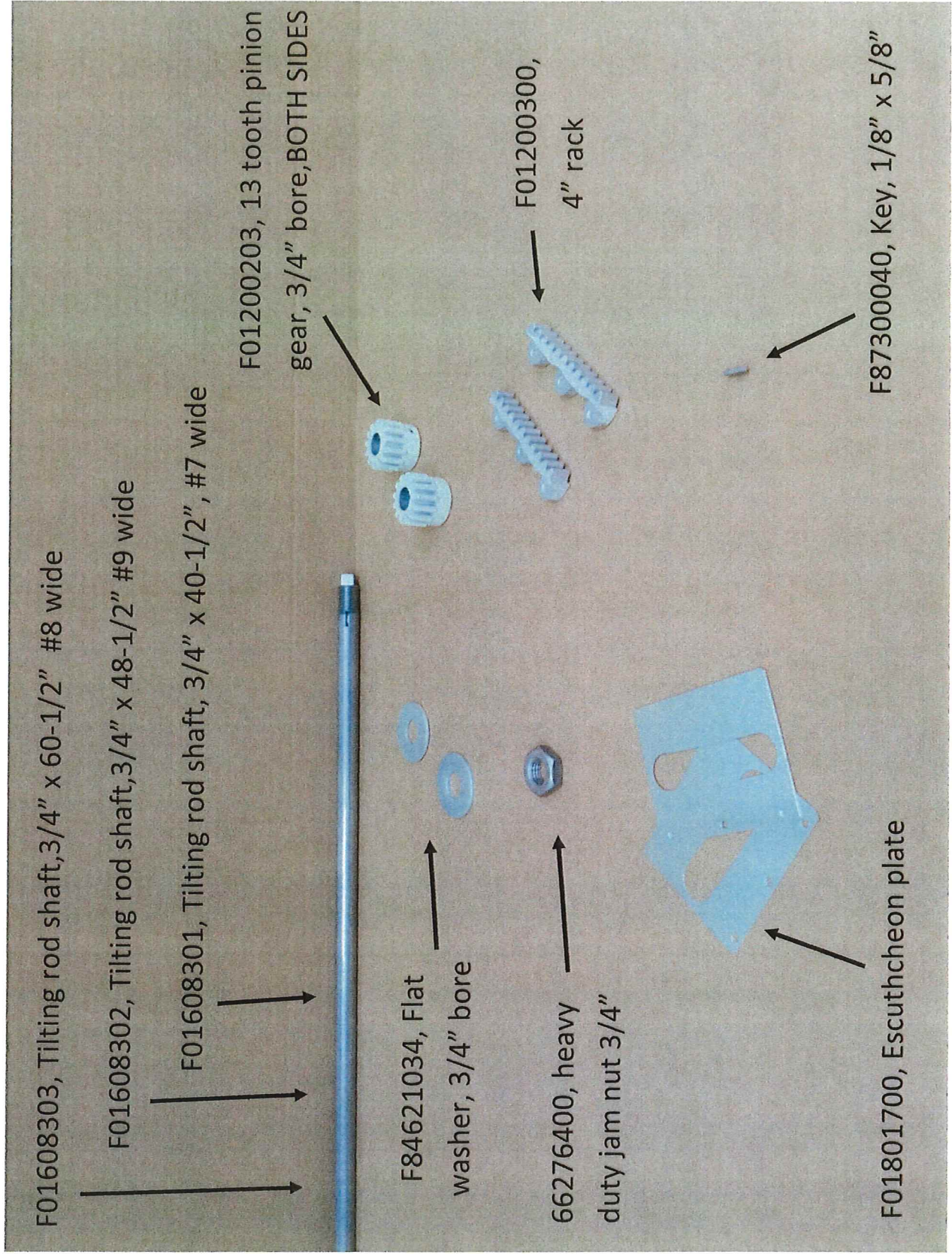

F01608303, Tilting rod shaft, 3/4" x 60-1/2" #8 wide

F01608302, Tilting rod shaft, 3/4" x 48-1/2" #9 wide

F01608301, Tilting rod shaft, 3/4" x 40-1/2", #7 wide

F01200203, 13 tooth pinion gear, 3/4" bore, BOTH SIDES

F84621034, Flat washer, 3/4" bore

66276400, heavy duty jam nut 3/4"

F01200300, 4" rack

F01801700, Escutcheon plate

F87300040, Key, 1/8" x 5/8"

# Screen rocker adjusting assembly



# Bottom Fan Metal

